

Features

- VibrAcoustic calms and soothes with sound vibration technology.
- Six concealed speakers send sound waves through the water to gently massage the body.
- Four original instrumental compositions offer different levels of relaxation.
- Syncs with devices enabled with BLUETOOTH® wireless technology including smartphones, MP3 players, tablets, and laptops located up to 33 feet away.*
- Customize your experience with the high-resolution color touch screen.
- Fully adjustable volume above and below the water.
- Functions as a hydrotherapy bath when full of water and a stereo system when empty.
- Includes 25 feet of wiring and amplifier.
- Hourglass shape adds style and elegance to your bathroom.
- Integral apron.
- Integral flange helps prevent water from seeping behind wall and simplifies alcove installation.
- Textured bottom surface
- Left-hand drain.

Material

- Acrylic

Hydrotherapy

- VibrAcoustic

Installation

- Three-wall alcove.
- Requires 110V electrical service.

Additional Hydrotherapy Options

- Soaking Bath - K-1242-LA
- Soaking Bath + Bask heated surface - K-1242-LAW
- BubbleMassage air bath - K-1239-GLA
- BubbleMassage air bath + Bask heated surface - K-1239-GLAW
- VibrAcoustic - K-1239-VBLA
- VibrAcoustic + Bask heated surface - K-1239-VBLAW
- Whirlpool - K-1239-LA
- Whirlpool + heater - K-1239-HL
- Whirlpool + Bask heated surface - K-1239-LAW

Recommended Products/Accessories

1184460 Under-Mount Installation Kit
K-1278 Removable Apron
K-1491 Bath/Whirlpool Pillow
K-1601 Bath/Whirlpool Footstop
K-7161-AF Bath Drain
K-7259 Clearflo Bath Drain



Codes/Standards





CSA B45.5/IAPMO Z124
ASTM E162
ASTM E662
UL 1795

KOHLER® Plastic Baths and Receptors Lifetime Limited Warranty

See website for detailed warranty information.

Available Colors/Finishes

Color tiles intended for reference only.

Color	Code	Description
	0	White
	96	Biscuit
	47	Almond
	NY	Dune
	G9	Sandbar

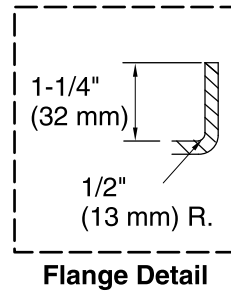
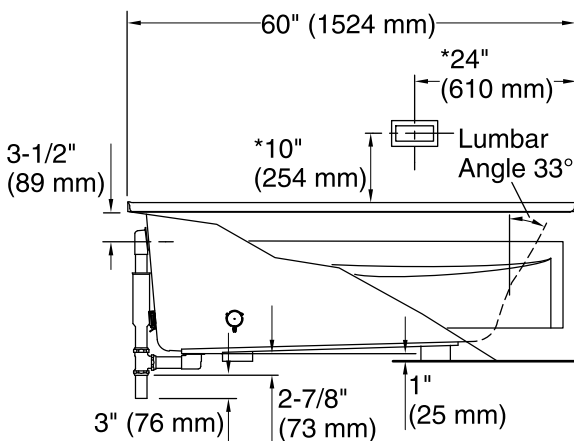
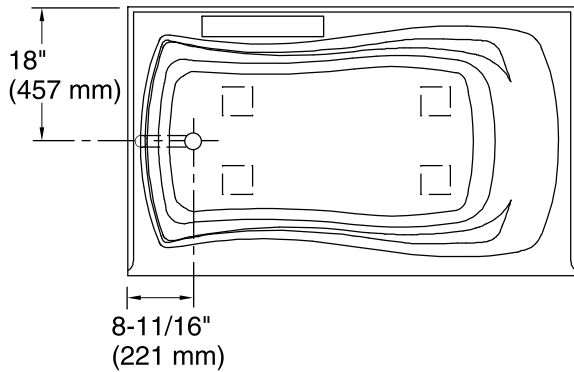

No changes in measurements if connected with drain illustrated. (K-7161-AF)

□ Recommended Faucet Location

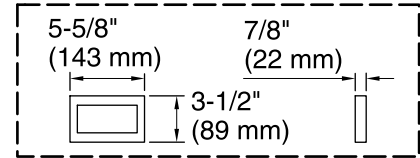

User Interface

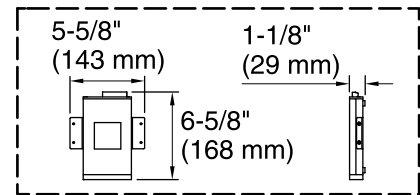

Amplifier

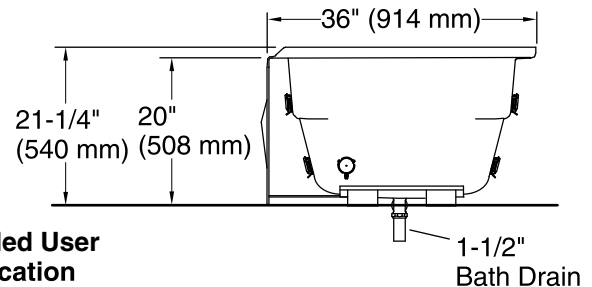

***Recommended User Interface Location**

Required Electrical Service

One circuit required, protected with Class A Ground-Fault Circuit-Interrupter (GFCI). Outside North America, this device may be known as a Residual Current Device (RCD).

Amplifier: 120 V, 15 A, 50/60 Hz

Technical Information

All product dimensions are nominal.

Installation:	Three-wall alcove
Drain location:	Left
Basin area, bottom:	46" x 24" (1168 mm x 610 mm)
Basin area, top:	54" x 27" (1372 mm x 686 mm)
Weight:	71 lbs (32.2 kg)
Minimum floor load:	42 lbs/ft ² (205.1 kg/m ²)
Water depth:	14" (356 mm)
Water capacity:	63 gal (238.5 L)
Electrical component rating:	Amplifier: 120 V, 50/60 Hz
Minimum flat for door:	2" (50 mm)
Bluetooth® range:	33 ft (0.8 m)

Notes

Measure your actual product for rough-in details. Install this product according to the installation instructions.

The hot water supply should be 70% of the capacity of the bath or greater. Installations will vary.

Control amplifier fits 16" (406 mm) center studs. 25' (7.6 m) cables are included.

If installing a rim-mount faucet, make sure there is no interference above or below the deck before drilling any holes.