

Features

- 60"L x 32"W x 20"H
- Standard-sized bath designed for quick and easy installation
- Three-wall alcove installation
- Constructed of acrylic
- Designed for one-person bathing
- Includes integral flange to simplify installation and prevent the possibility of water damage behind the wall
- Textured bottom surface

Additional Hydrotherapy Options

- Soaking Bath - 1219-L
- Whirlpool - 1209-L
- Whirlpool + heater - 1209-LH

Recommended Products/Accessories

K-1278 Removable Apron
K-7161-AF Bath Drain
K-24916 Wireless Music Kit
K-1601 Bath/Whirlpool Footstop
K-7213 27" Cable Bath Drain
K-7214 27" Cable Bath Drain
K-7259 Clearflo Bath Drain
K-702200-G54 Frameless Sliding Bath Door
K-702200-G73 Frameless Sliding Bath Door
K-702200-L Frameless Sliding Bath Door
K-702205-L Frameless Sliding Bath Door



Codes/Standards



CSA B45.5/IAPMO Z124
ASTM E162
ASTM E662

KOHLER® Plastic Baths and Receptors Lifetime Limited Warranty

See website for detailed warranty information.

Available Colors/Finishes

Color tiles intended for reference only.

Color	Code	Description
	0	White
	96	Biscuit
	47	Almond

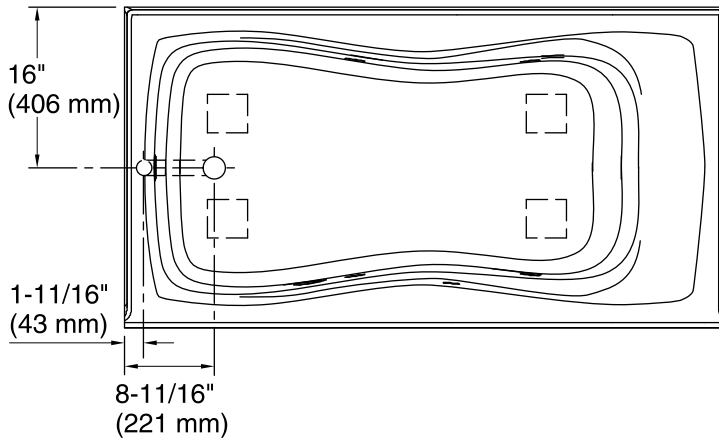

No change in measurements if connected with drain illustrated. (K-7161-AF)

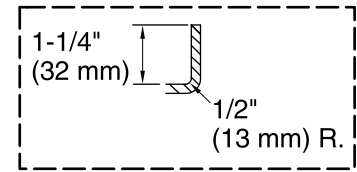

Integral Flange Detail

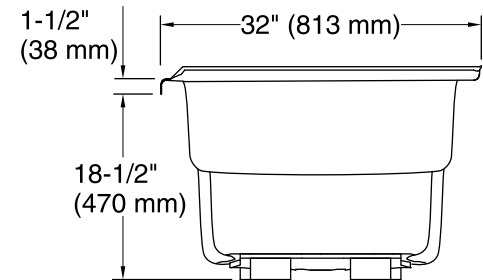
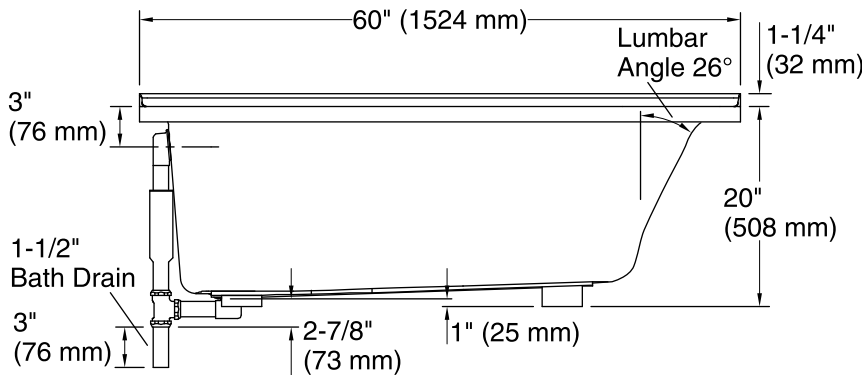

Technical Information

All product dimensions are nominal.

Installation:	Three-wall alcove
Drain location:	Left
Basin area, bottom:	45-1/8" x 20" (1146 mm x 508 mm)
Basin area, top:	53" x 23" (1346 mm x 584 mm)
Weight:	80 lbs (36.3 kg)
Minimum floor load:	48 lbs/ft ² (234.4 kg/m ²)
Water depth:	14-1/2" (368 mm)
Water capacity:	64 gal (242.3 L)
Minimum flat for door:	2-3/8" (60 mm)

Notes

Measure your actual product for rough-in details.

Install this product according to the installation instructions.

The hot water supply should be 70% of the capacity of the bath or greater. Installations will vary.