

Features

- VibrAcoustic calms and soothes with sound vibration technology.
- Six concealed speakers send sound waves through the water to gently massage the body.
- Four original instrumental compositions offer different levels of relaxation.
- Syncs with devices enabled with BLUETOOTH® wireless technology including smartphones, MP3 players, tablets, and laptops located up to 33 feet away.*
- Customize your experience with the high-resolution color touch screen.
- Fully adjustable volume above and below the water.
- Functions as a hydrotherapy bath when full of water and a stereo system when empty.
- Bask® heated surface creates spa-like relaxation with soothing warmth on your back and neck.
- Three heat settings allow you to customize the surface temperature.
- Generous 6-foot length provides an incredibly spacious bathing area.
- Clearflo slotted overflow for deep soaking.
- Includes 25 feet of wiring and amplifier.

Material

- Acrylic

Hydrotherapy

- VibrAcoustic

Installation

- Drop-in or under-mount.
- Requires 110V electrical service.

Additional Hydrotherapy Options

- Soaking Bath - K-1137-0
- Soaking Bath + Bask heated surface - K-1137-W1
- BubbleMassage air bath - K-1174-G
- BubbleMassage air bath + chromatherapy - K-1174-GCR
- VibrAcoustic + BubbleMassage air bath - K-1174-GVB
- VibrAcoustic + BubbleMassage air bath + Bask heated surface + chromatherapy - K-1174-GVBCW
- BubbleMassage air bath + Bask heated surface - K-1174-GW
- Whirlpool + heater - K-1174-H2
- VibrAcoustic - K-1174-VB
- VibrAcoustic + chromatherapy - K-1174-VBC
- VibrAcoustic + chromatherapy + Bask heated surface - K-1174-VBCW
- VibrAcoustic + Bask heated surface - K-1174-VBW
- Whirlpool + BubbleMassage air bath - K-1174-XH2G



Codes/Standards

CSA B45.5/IAPMO Z124
ASTM E162
ASTM E662
UL 1795
CSA C22.2 No. 218.2









KOHLER® Plastic Baths and Receptors Lifetime Limited Warranty

See website for detailed warranty information.

The BLUETOOTH® word mark and logos are registered trademarks owned by Bluetooth SIG, Inc. and any use of such marks by Kohler Co. is under license. Other trademarks and trade names are those of their respective owners.

Available Colors/Finishes

Color tiles intended for reference only.

Color	Code	Description
	0	White
	96	Biscuit
	47	Almond
	NY	Dune
	95	Ice™ Grey
	G9	Sandbar
	K4	Cashmere
	58	Thunder™ Grey
	7	Black Black™

No change in measurements if connected with required drain illustrated. (K-7272)

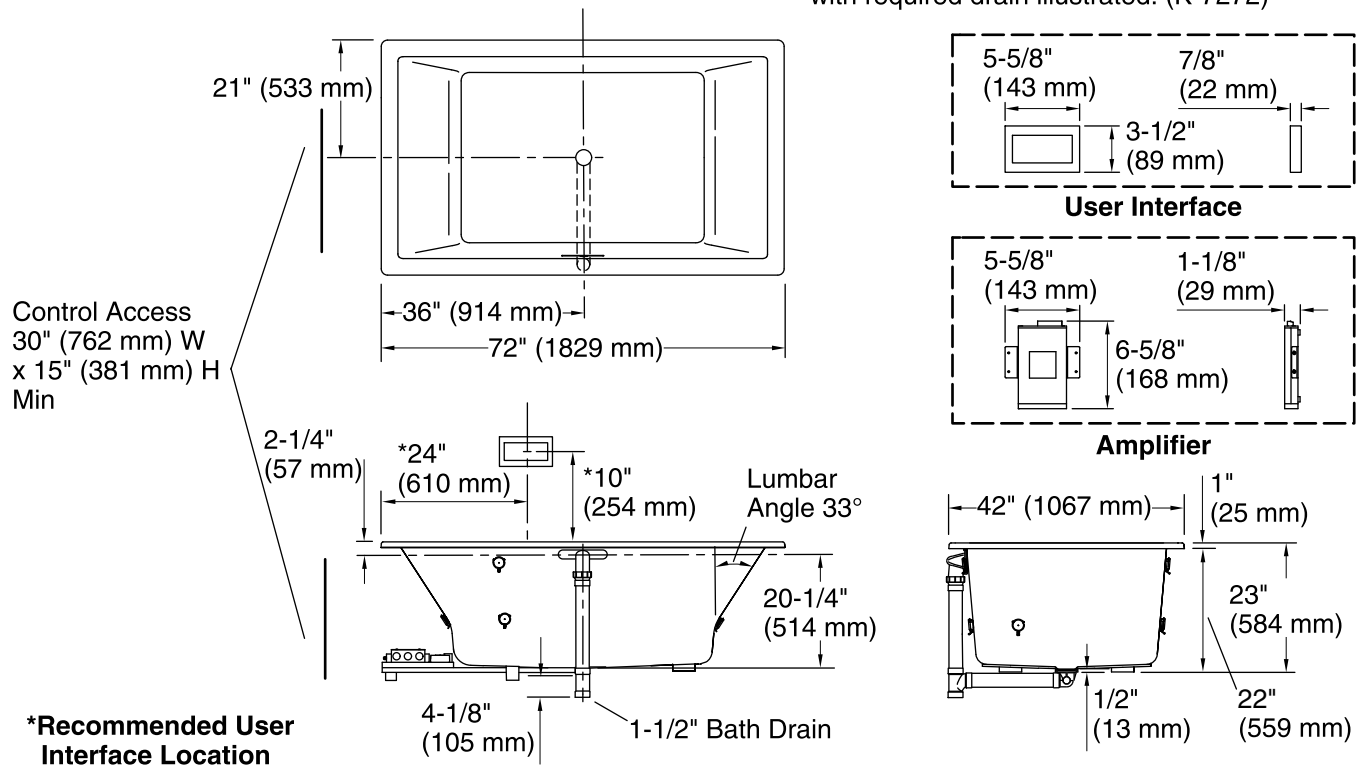

Required Electrical Service

One circuit required, protected with Class A Ground-Fault Circuit-Interrupter (GFCI). Outside North America, this device may be known as a Residual Current Device (RCD).

Amplifier, Heated Surface: 120 V, 15 A, 50/60 Hz

Technical Information

All product dimensions are nominal.

Installation:	Drop-in, Under-mount
Drain location:	Center
Basin area, bottom:	45-3/4" x 32" (1162 mm x 813 mm)
Basin area, top:	66" x 36" (1676 mm x 914 mm)
Weight:	95 lbs (43.1 kg)
Minimum floor load:	61 lbs/ft ² (297.8 kg/m ²)
Water depth:	19" (483 mm)
Water capacity:	139 gal (526.2 L)
Cutout:	Drop-in, 70-1/2" x 40-1/2" (1791 mm x 1029 mm)
Electrical component rating:	Amplifier: 120 V, 1.1 A, 50/60 Hz Heated Surface: 120 V, 0.5 A, 50/60 Hz, 65 W

Notes

Measure your actual product for rough-in details. Install this product according to the installation instructions.

The hot water supply should be 70% of the capacity of the bath or greater. Installations will vary.

Kit is required for under-mount installations (sold separately).

Control amplifier fits 16" (406 mm) center studs. 25' (7.6 m) cables are included.