

### Features

- VibrAcoustic calms and soothes with sound vibration technology.
- Six concealed speakers send sound waves through the water to gently massage the body.
- Four original instrumental compositions offer different levels of relaxation.
- Syncs with devices enabled with BLUETOOTH® wireless technology including smartphones, MP3 players, tablets, and laptops located up to 33 feet away.\*
- Customize your experience with the high-resolution color touch screen.
- Fully adjustable volume above and below the water.
- Functions as a hydrotherapy bath when full of water and a stereo system when empty.
- Chromatherapy lighting allows you to select a preferred color scheme to suit your mood.
- Clearflo slotted overflow for deep soaking.
- Includes 25 feet of wiring and amplifier.

### Material

- Acrylic

### Hydrotherapy

- VibrAcoustic
- Chromatherapy

### Installation

- Drop-in or under-mount.
- Requires 110V electrical service.

### Additional Hydrotherapy Options

- Soaking Bath - K-1130-0
- Soaking Bath + Bask heated surface - K-1130-W1
- BubbleMassage air bath - K-1168-G
- BubbleMassage air bath + chromatherapy - K-1168-GCR
- VibrAcoustic + BubbleMassage air bath - K-1168-GVB
- VibrAcoustic + BubbleMassage air bath + Bask heated surface + chromatherapy - K-1168-GVBCW
- BubbleMassage air bath + Bask heated surface - K-1168-GW
- Whirlpool + heater - K-1168-H2
- VibrAcoustic - K-1168-VB
- VibrAcoustic + chromatherapy - K-1168-VBC
- VibrAcoustic + chromatherapy + Bask heated surface - K-1168-VBCW
- VibrAcoustic + Bask heated surface - K-1168-VBW
- Whirlpool + BubbleMassage air bath - K-1168-XH2G

### Required Products/Accessories

K-7271 Brass Slotted Overflow Bath Drain



### Codes/Standards

CSA B45.5/IAPMO Z124  
ASTM E162  
ASTM E662  
UL 1795  
CSA C22.2 No. 218.2











### KOHLER® Plastic Baths and Receptors Lifetime Limited Warranty

See website for detailed warranty information.

The BLUETOOTH® word mark and logos are registered trademarks owned by Bluetooth SIG, Inc. and any use of such marks by Kohler Co. is under license. Other trademarks and trade names are those of their respective owners.

### Available Colors/Finishes

*Color tiles intended for reference only.*

Color	Code	Description
	0	White
	96	Biscuit
	47	Almond
	NY	Dune
	95	Ice™ Grey
	G9	Sandbar
	33	Mexican Sand™
	K4	Cashmere
	58	Thunder™ Grey
	7	Black Black™

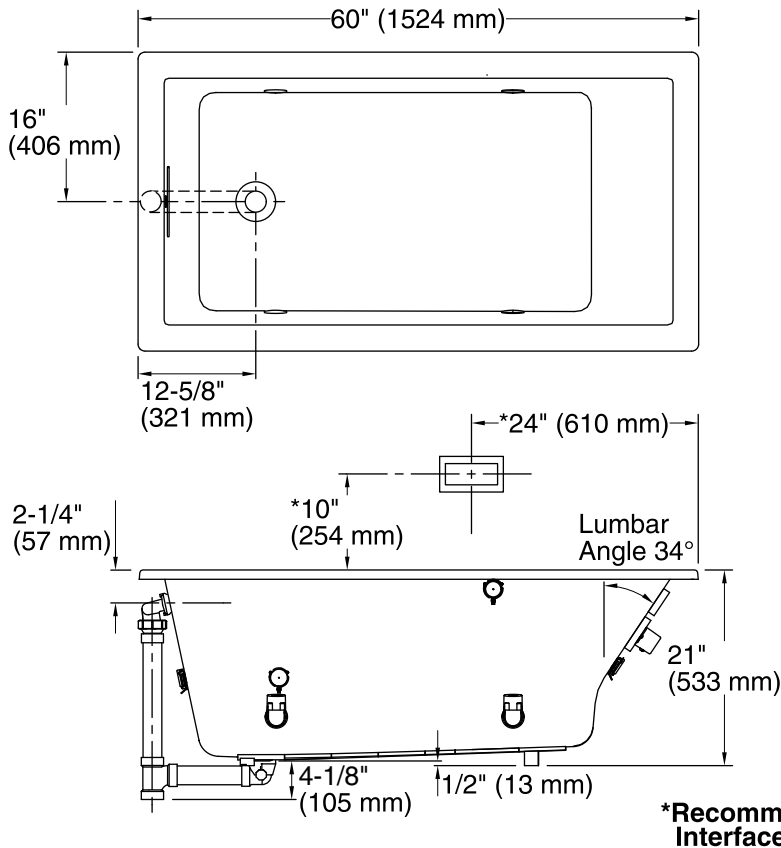

No change in measurement if connected with drain illustrated. (K-7272)

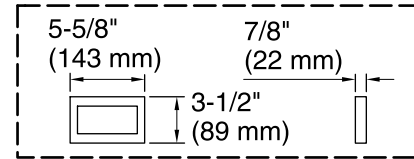

**User Interface**

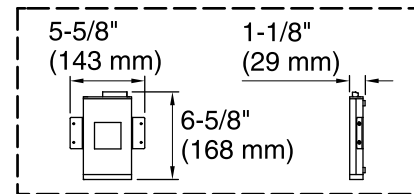

**Amplifier**

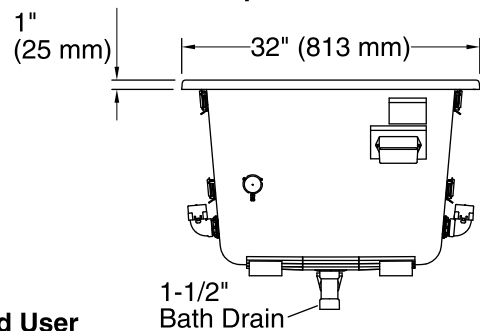

### Required Electrical Service

One circuit required, protected with Class A Ground-Fault Circuit-Interrupter (GFCI). Outside North America, this device may be known as a Residual Current Device (RCD).

Amplifier: 120 V, 15 A, 50/60 Hz

### Technical Information

All product dimensions are nominal.

Installation: Drop-in, Under-mount

Drain location: End

Basin area, bottom: 42" x 23-1/2" (1067 mm x 597 mm)

Basin area, top: 55-1/8" x 27-1/8" (1400 mm x 689 mm)

Weight: 85 lbs (38.6 kg)

Minimum floor load: 58.6 lbs/ft<sup>2</sup> (286.1 kg/m<sup>2</sup>)

Water capacity: 81 gal (306.6 L)

Cutout: Drop-in, 59-1/2" x 31-1/2" (1511 mm x 800 mm)

Electrical component rating: Amplifier: 120 V, 1.1 A, 50/60 Hz

Amplifier channels: 2 at 15 W per channel  
2 at 30 W per channel

Minimum flat for door: 2" (51 mm)

### Notes

Measure your actual product for rough-in details. Install this product according to the installation instructions.

The hot water supply should be 70% of the capacity of the bath or greater. Installations will vary.

Kit is required for under-mount installations (sold separately).

Control amplifier fits 16" (406 mm) center studs. 25' (7.6 m) cables are included.