

Features

- Single-speed whirlpool offers performance and value, with 6 fully adjustable jets.
- Hydromassage flow and direction can be controlled at each jet.
- Built-in heater.
- Corner layout minimizes footprint without compromising bathing area.
- Spacious design accommodates up to two bathers.
- Molded lumbar supports and armrests offer extra comfort while bathing.
- Center drain.

Material

- Acrylic

Hydrotherapy

- Whirlpool

Installation

- Drop-in

Additional Hydrotherapy Options

- Soaking Bath - K-1161-F
- Whirlpool - K-1160-F
- Whirlpool + heater - K-1160-FH

Recommended Products/Accessories

K-11677 Bath Drain
K-1491 Bath/Whirlpool Pillow
K-1601 Bath/Whirlpool Footstop
K-7259 Clearflo Bath Drain
K-37382 45" Rough-in Cable Bath Drain



Codes/Standards

ASME A112.19.7/CSA B45.10
CSA B45.5/IAPMO Z124
ASTM E162
ASTM E662
UL 1795



**KOHLER® Plastic Baths and Receptors
Lifetime Limited Warranty
KOHLER® Hydrotherapy Components
Five-Year Limited Warranty**

See website for detailed warranty information.

Available Colors/Finishes

Color tiles intended for reference only.

Color Code Description

	0	White
	96	Biscuit
	47	Almond

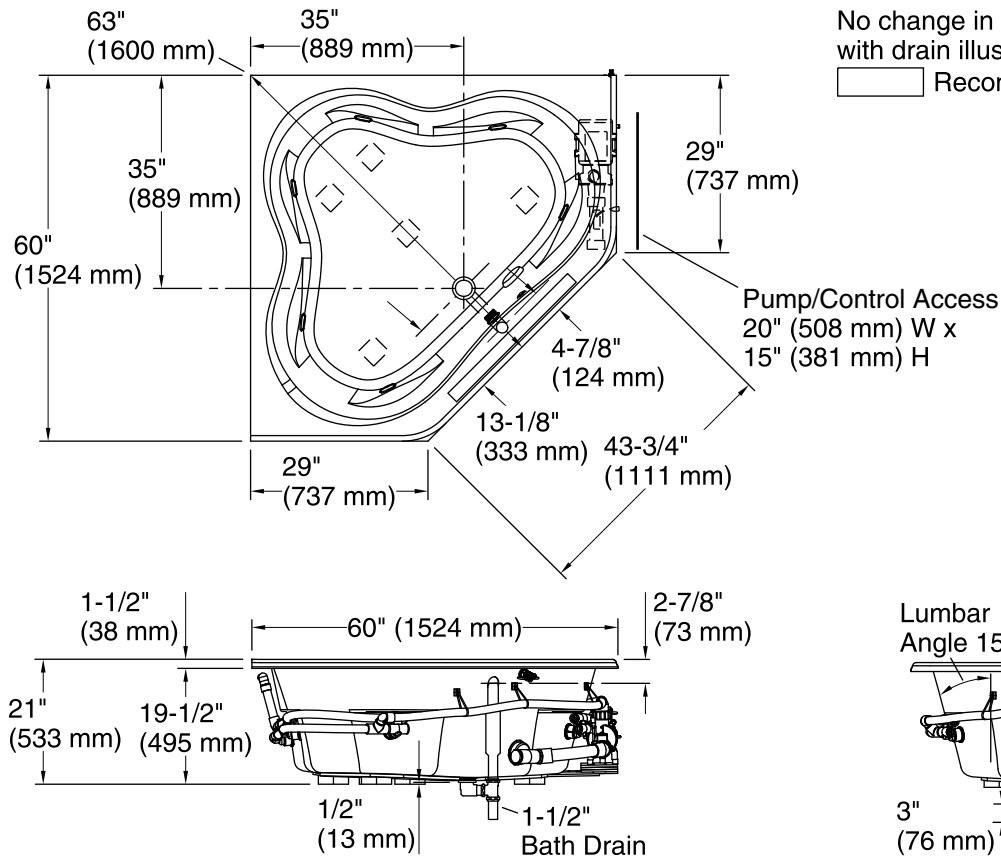

No change in measurements if connected with drain illustrated. (K-11677)

□ Recommended Faucet Location

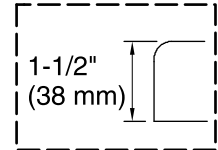

Drop-in Rim Detail

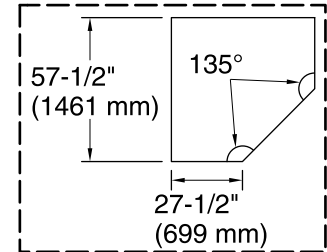

Drop-In Rim Style Cut-Out Detail

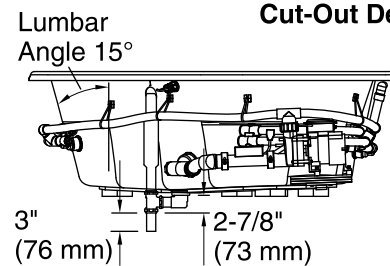

Required Electrical Service

Two dedicated circuits required, protected with Class A Ground-Fault Circuit-Interrupter (GFCI). Outside North America, this device may be known as a Residual Current Device (RCD).

Pump:	120 V, 15 A, 60 Hz
Heater:	120 V, 15 A, 60 Hz

Technical Information

All product dimensions are nominal.

Installation:	Drop-in
Drain location:	Center
Basin area, bottom:	52" x 38-3/4" (1321 mm x 984 mm)
Basin area, top:	61" x 46-1/4" (1549 mm x 1175 mm)
Weight:	131 lbs (59.4 kg)
Minimum floor load:	39 lbs/ft ² (190.4 kg/m ²)
Water depth:	15" (381 mm)
Water capacity:	96 gal (363.4 L)
Electrical component rating:	Pump: 120 V, 7.5 A, 60 Hz Heater: 120 V, 12.5 A, 60 Hz, 1500 W
Pump speed:	Single

Notes

Measure your actual product for rough-in details. Install this product according to the installation instructions.

The hot water supply should be 70% of the capacity of the bath or greater. Installations will vary.

Provide one grounded electrical outlet within 24" (610 mm) of each component.

If installing a rim-mount faucet, make sure there is no interference above or below the deck before drilling any holes.