

### Features

- Single-speed whirlpool offers performance and value, with 8 fully adjustable jets.
- Hydromassage flow and direction can be controlled at each jet.
- Molded lumbar support offers extra comfort while bathing.
- Integral apron.
- Integral flange helps prevent water from seeping behind wall and simplifies alcove installation.
- Textured bottom surface
- Left-hand drain.
- Coordinates with other products in the Bancroft collection.

### Material

- Acrylic

### Hydrotherapy

- Whirlpool

### Installation

- Three-wall alcove.

### Additional Hydrotherapy Options

- Soaking Bath - 1150-LA
- Soaking Bath + Bask heated surface - 1150-LAW
- BubbleMassage air bath - 1151-GLA
- VibrAcoustic - 1151-VBLA
- VibrAcoustic + Bask heated surface - 1151-VBLAW
- Whirlpool - 1151-LA
- Whirlpool + heater - 1151-HL
- Whirlpool + Bask heated surface - 1151-LAW

### Recommended Products/Accessories

- K-11677 Bath Drain
- K-24916 Wireless Music Kit



### Codes/Standards

ASME A112.19.7/CSA B45.10  
CSA B45.5/IAPMO Z124  
ASTM E162  
ASTM E662  
UL 1795





**KOHLER® Plastic Baths and Receptors  
Lifetime Limited Warranty  
KOHLER® Hydrotherapy Components  
Five-Year Limited Warranty**

See website for detailed warranty information.

### Available Colors/Finishes

*Color tiles intended for reference only.*

Color	Code	Description
-------	------	-------------

	0	White
	96	Biscuit
	47	Almond
	NY	Dune
	G9	Sandbar

No change in measurements if connected with drain illustrated. (K-11677)

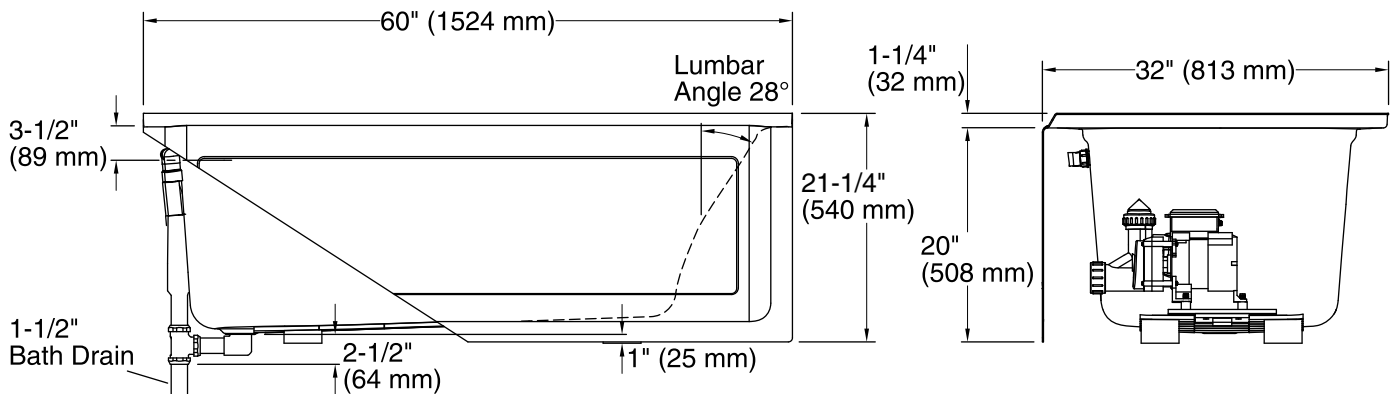
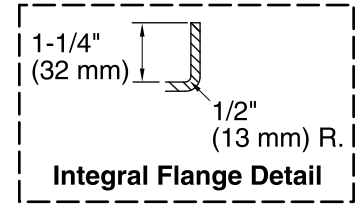
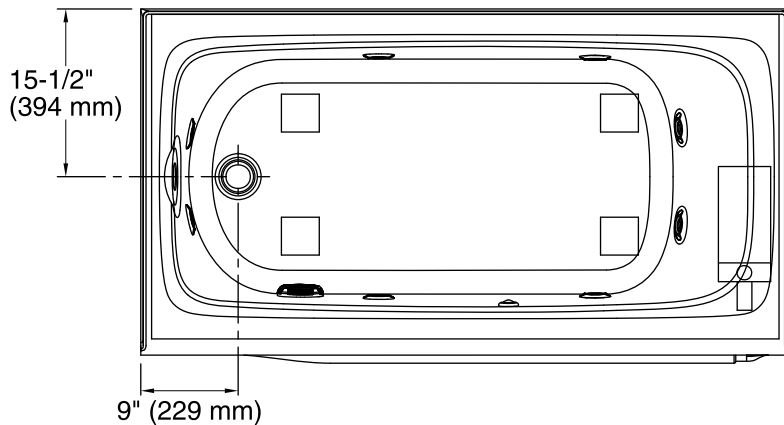

### Required Electrical Service

One dedicated circuit required, protected with Class A Ground-Fault Circuit-Interrupter (GFCI). Outside North America, this device may be known as a Residual Current Device (RCD).

Pump: 120 V, 15 A, 60 Hz

### Technical Information

All product dimensions are nominal.

Installation:	Three-wall alcove
Drain location:	Left
Basin area, bottom:	45" x 22" (1143 mm x 559 mm)
Basin area, top:	54" x 25" (1372 mm x 635 mm)
Weight:	135 lbs (61.2 kg)
Minimum floor load:	50 lbs/ft <sup>2</sup> (244.1 kg/m <sup>2</sup> )
Water depth:	15" (381 mm)
Water capacity:	60 gal (227.1 L)
Electrical component rating:	Pump: 120 V, 7 A, 60 Hz
Pump speed:	Single
Minimum flat for door:	2" (51 mm)

### Notes

Measure your actual product for rough-in details. Install this product according to the installation instructions.

The hot water supply should be 70% of the capacity of the bath or greater. Installations will vary.

Provide one grounded electrical outlet within 24" (610 mm) of each component.