

Features

- Single-speed whirlpool offers performance and value with 8 fully adjustable jets.
- Hydromassage flow and direction can be controlled at each jet.
- Built-in heater.
- Molded lumbar support offers extra comfort while bathing.
- Integral apron.
- Integral flange helps prevent water from seeping behind wall and simplifies alcove installation.
- Textured bottom surface
- Right-hand drain.
- Coordinates with other products in the Bancroft collection.

Material

- Acrylic

Hydrotherapy

- Whirlpool

Installation

- Three-wall alcove.

Additional Hydrotherapy Options

- Soaking Bath - 1150-RA
- Soaking Bath + Bask heated surface - 1150-RAW
- BubbleMassage air bath - 1151-GRA
- VibrAcoustic - 1151-VBRA
- VibrAcoustic + Bask heated surface - 1151-VBRAW
- Whirlpool - 1151-RA
- Whirlpool + heater - 1151-HR
- Whirlpool + Bask heated surface - 1151-RAW

Recommended Products/Accessories

K-11677 Bath Drain
K-24916 Wireless Music Kit
K-1491 Bath/Whirlpool Pillow
K-1601 Bath/Whirlpool Footstop
K-37380 30" Rough-in Cable Bath Drain
K-37383 30" Rough-in Cable Bath Drain
K-702200-G54 Frameless Sliding Bath Door
K-702200-G73 Frameless Sliding Bath Door
K-702200-L Frameless Sliding Bath Door
K-702205-L Frameless Sliding Bath Door
K-706000-D3 Frameless Sliding Bath Door
K-706000-L Frameless Sliding Bath Door
K-706003-L Frameless Sliding Bath Door
K-706004-D3 Frameless Sliding Bath Door
K-706004-L Frameless Sliding Bath Door
K-706007-L Frameless Sliding Bath Door



Codes/Standards

ASME A112.19.7/CSA B45.10
CSA B45.5/IAPMO Z124
ASTM E162
ASTM E662
UL 1795





**KOHLER® Plastic Baths and Receptors
Lifetime Limited Warranty
KOHLER® Hydrotherapy Components
Five-Year Limited Warranty**

See website for detailed warranty information.

Available Colors/Finishes

Color tiles intended for reference only.

Color Code Description

	0	White
	96	Biscuit
	47	Almond
	NY	Dune
	G9	Sandbar

No change in measurements if connected with drain illustrated. (K-11677)

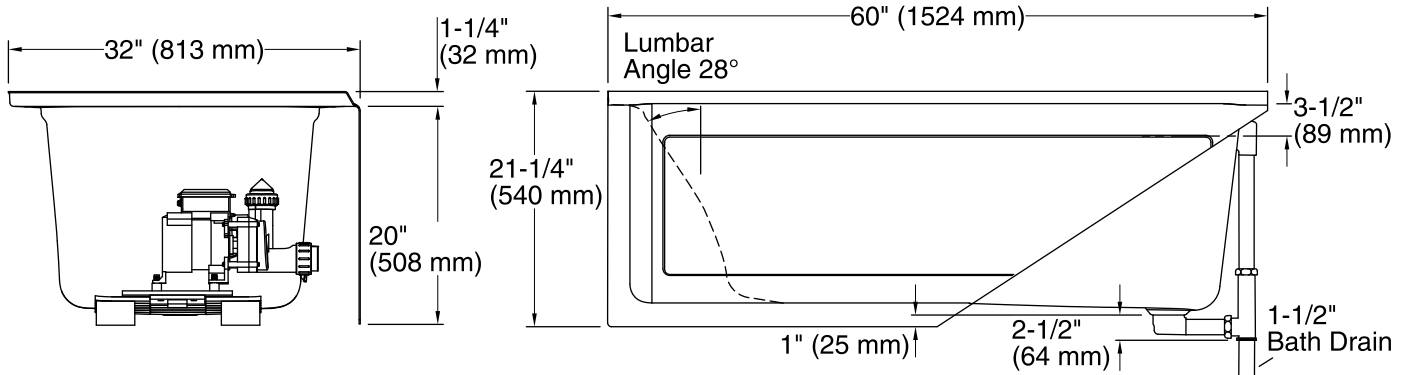
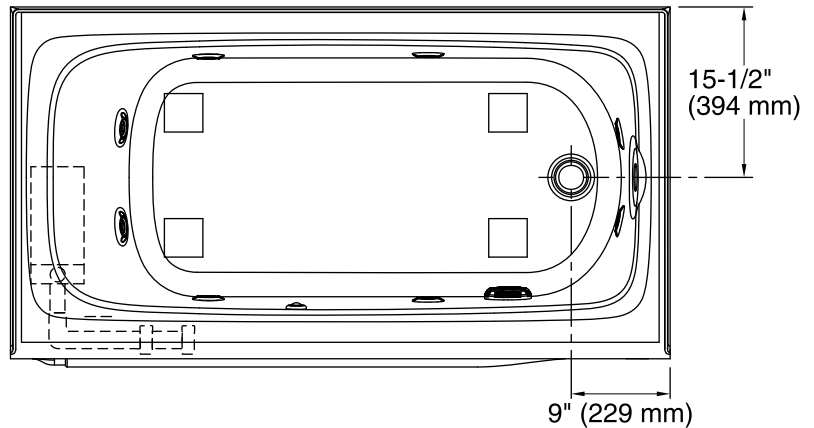
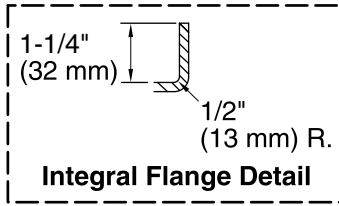

Required Electrical Service

Two dedicated circuits required, protected with Class A Ground-Fault Circuit-Interrupter (GFCI). Outside North America, this device may be known as a Residual Current Device (RCD).

Pump: 120 V, 15 A, 60 Hz
Heater: 120 V, 15 A, 60 Hz

Technical Information

All product dimensions are nominal.

Installation: Three-wall alcove
Drain location: Right
Basin area, bottom: 45" x 22" (1143 mm x 559 mm)
Basin area, top: 54" x 25" (1372 mm x 635 mm)
Weight: 140 lbs (63.5 kg)
Minimum floor load: 50 lbs/ft² (244.1 kg/m²)
Water depth: 15" (381 mm)
Water capacity: 60 gal (227.1 L)
Electrical component rating: Pump: 120 V, 7 A, 60 Hz
Heater: 120 V, 12.5 A, 60 Hz, 1500 W
Pump speed: Single
Minimum flat for door: 2" (51 mm)

Notes

Measure your actual product for rough-in details. Install this product according to the installation instructions.
The hot water supply should be 70% of the capacity of the bath or greater. Installations will vary.
Provide one grounded electrical outlet within 24" (610 mm) of each component.