

Features

- Bask® heated surface creates spa-like relaxation with soothing warmth on your back and neck.
- Three heat settings allow you to customize the surface temperature.
- 120 airjets release thousands of bubbles that surround, support, and massage the body.
- Variable-speed blower lets you adjust massage intensity to 18 levels.
- Molded lumbar support offers extra comfort while bathing.
- Integral apron.
- Integral flange helps prevent water from seeping behind wall and simplifies alcove installation.
- Textured bottom surface
- Immediate and manual purge cycles remove residual water from air channels after use.
- Right-hand drain.
- Coordinates with other products in the Bancroft collection.

Material

- Acrylic

Hydrotherapy

- BubbleMassage

Installation

- Three-wall alcove.

Additional Hydrotherapy Options

- Soaking Bath - 1150-RA
- Soaking Bath + Bask heated surface - 1150-RAW
- BubbleMassage air bath - 1151-GRA
- VibrAcoustic - 1151-VBRA
- VibrAcoustic + Bask heated surface - 1151-VBRAW
- Whirlpool - 1151-RA
- Whirlpool + heater - 1151-HR
- Whirlpool + Bask heated surface - 1151-RAW

Recommended Products/Accessories

K-11677 Bath Drain
K-1446 Remote Installation Kit
K-9497 2-1/2" Keypad Trim
K-24916 Wireless Music Kit



Codes/Standards





ASME A112.19.7/CSA B45.10
CSA B45.5/IAPMO Z124
ASTM E162
ASTM E662
UL 1795

**KOHLER® Plastic Baths and Receptors
Lifetime Limited Warranty
KOHLER® Hydrotherapy Components
Five-Year Limited Warranty**

See website for detailed warranty information.

Available Colors/Finishes

Color tiles intended for reference only.

Color	Code	Description
	0	White
	96	Biscuit
	47	Almond
	NY	Dune
	G9	Sandbar

No change in measurements if connected with drain illustrated. (K-11677)

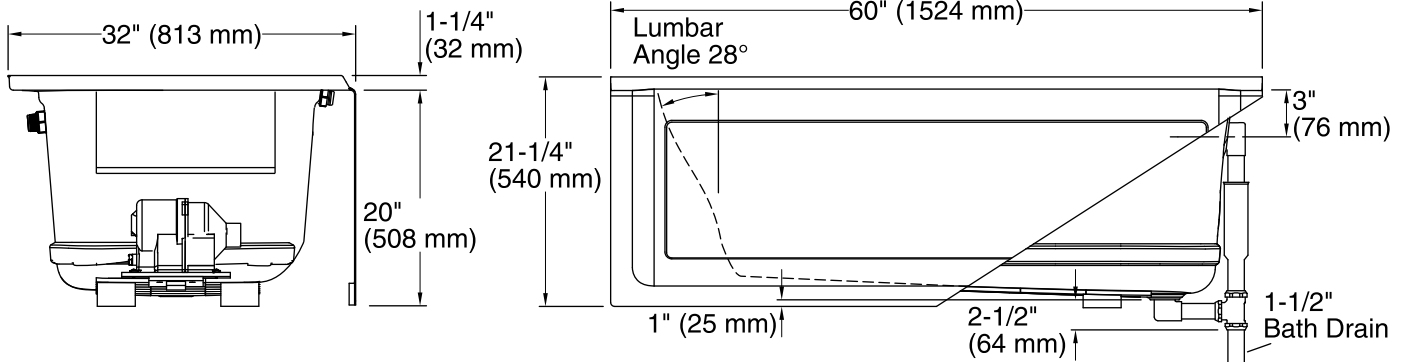
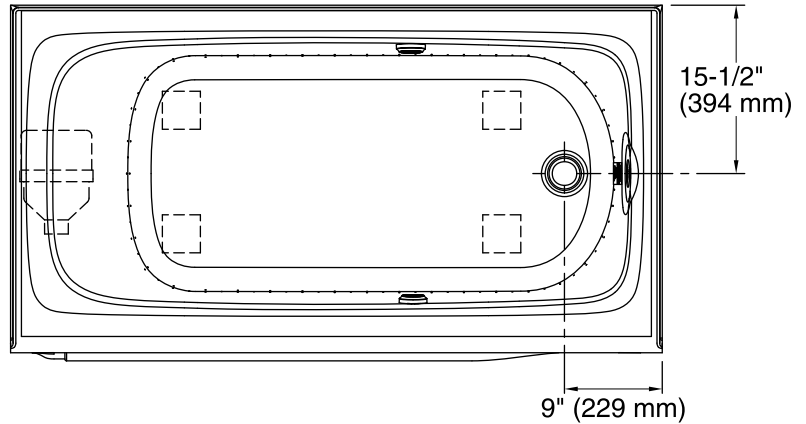
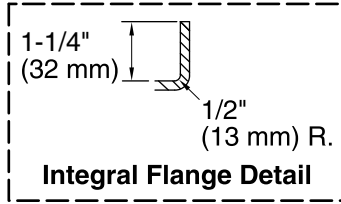

Required Electrical Service

One dedicated circuit required, protected with Class A Ground-Fault Circuit-Interrupter (GFCI). Outside North America, this device may be known as a Residual Current Device (RCD).

Blower, Heated 120 V, 15 A, 60 Hz
Surface:

Technical Information

All product dimensions are nominal.

Installation: Three-wall alcove
Drain location: Right
Basin area, bottom: 45" x 22" (1143 mm x 559 mm)
Basin area, top: 54" x 25" (1372 mm x 635 mm)
Weight: 106 lbs (48.1 kg)
Minimum floor load: 49 lbs/ft² (239.2 kg/m²)
Water depth: 15" (381 mm)
Water capacity: 60 gal (227.1 L)
Electrical component rating:
Blower: 120 V, 10 A, 60 Hz
Heated Surface: 120 V, 0.5 A, 60 Hz, 65 W
Minimum flat for door: 2" (51 mm)

Notes

Measure your actual product for rough-in details. Install this product according to the installation instructions.

The hot water supply should be 70% of the capacity of the bath or greater. Installations will vary.

Remote blower installation kit is available for relocating the blower. Provide access for servicing the blower.

Do not relocate or alter the PVC tee or coiled flexible tubing connected to the blower. Follow the blower relocation instructions exactly.