

Features

- The K-1124-XHG bath offers both a whirlpool hydromassage and BubbleMassage air bubbles for a truly relaxing bathing experience.
- 118 airjets release thousands of bubbles that surround, support, and massage the body.
- Variable-speed blower lets you adjust massage intensity to 18 levels.
- Single-speed whirlpool offers performance and value, with 8 fully adjustable jets.
- Hydromassage flow and direction can be controlled at each jet.
- Built-in heater.
- Comfort Depth® design offers a convenient 19-inch step-over height while retaining the same depth as a standard 21-inch bath.
- Generous 6-foot length provides an incredibly spacious bathing area.
- Molded lumbar support offers extra comfort while bathing.
- Slotted overflow allows for deep soaking.
- Textured bottom surface.
- Reversible drain.
- Coordinates with other products in the Archer collection.

Material

- Acrylic

Hydrotherapy

- BubbleMassage
- Whirlpool

Installation

- Drop-in

Additional Hydrotherapy Options

- Soaking Bath - K-1125-0
- Soaking Bath + Bask heated surface - K-1125-W1
- BubbleMassage air bath - K-1124-G
- BubbleMassage air bath + Bask heated surface - K-1124-GW
- VibrAcoustic - K-1124-VB
- VibrAcoustic + Bask heated surface - K-1124-VBW
- Whirlpool - K-1124-0
- Whirlpool + heater - K-1124-H
- Whirlpool + Bask heated surface - K-1124-W1
- Whirlpool + BubbleMassage air bath - K-1124-XHG

Required Products/Accessories

K-7271 Brass Slotted Overflow Bath Drain

or

K-7272 PVC Slotted Overflow Bath Drain



ADA

Codes/Standards











ASME A112.19.7/CSA B45.10
CSA B45.5/IAPMO Z124
ASTM E162
UL 1795
ADA
ICC/ANSI A117.1

**KOHLER® Plastic Baths and Receptors
Lifetime Limited Warranty
KOHLER® Hydrotherapy Components
Five-Year Limited Warranty**

See website for detailed warranty information.

Available Colors/Finishes

Color tiles intended for reference only.

Color	Code	Description
	0	White
	96	Biscuit
	47	Almond
	NY	Dune
	95	Ice™ Grey
	G9	Sandbar
	33	Mexican Sand™
	K4	Cashmere
	58	Thunder™ Grey
	7	Black Black™

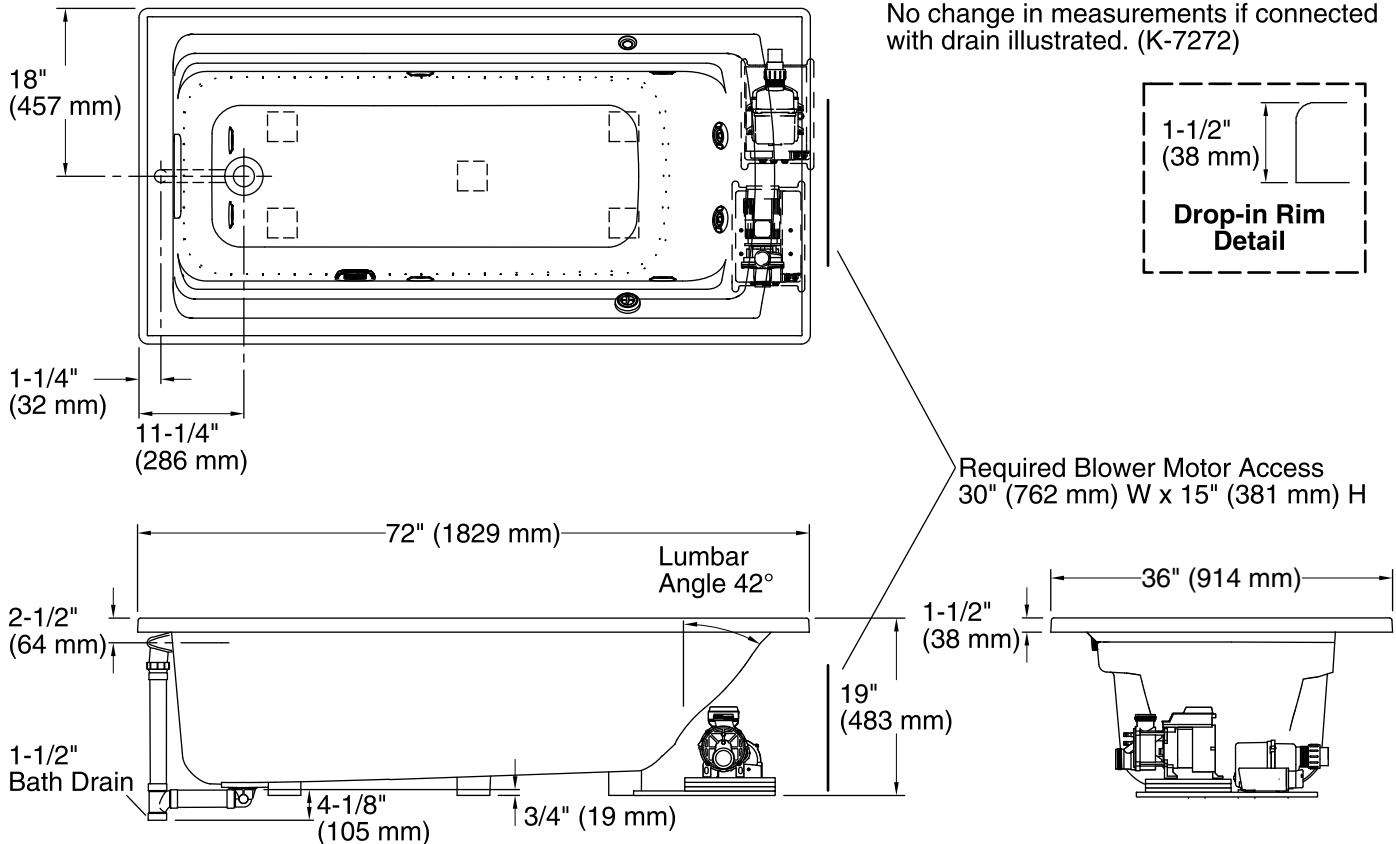

Required Electrical Service

Three dedicated circuits required, protected with Class A Ground-Fault Circuit-Interrupter (GFCI). Outside North America, this device may be known as a Residual Current Device (RCD).

Pump:	120 V, 15 A, 60 Hz
Blower:	120 V, 15 A, 60 Hz
Heater:	120 V, 15 A, 60 Hz

Technical Information

All product dimensions are nominal.

Installation:	Drop-in
Drain location:	End
Basin area, bottom:	51-3/8" x 21" (1305 mm x 533 mm)
Basin area, top:	64-1/2" x 30-1/2" (1638 mm x 775 mm)
Weight:	140 lbs (63.5 kg)
Minimum floor load:	43 lbs/ft ² (209.9 kg/m ²)
Water depth:	15" (381 mm)
Water capacity:	72 gal (272.5 L)
Cutout:	Drop-in, 70-1/2" x 34-1/2" (1791 mm x 876 mm)

Notes

Measure your actual product for rough-in details. Install this product according to the installation instructions.

The hot water supply should be 70% of the capacity of the bath or greater. Installations will vary.

This product is designed for drop-in installation only. It is not suited for use in a three-wall alcove with an overhead shower.

Remote blower installation kit is available for relocating the blower. Provide access for servicing the blower.

Do not relocate or alter the PVC tee or coiled flexible tubing connected to the blower. Follow the blower relocation instructions exactly.

ADA compliant when installed to the specific requirements of these regulations.