

Features

- Round basin
- With overflow
- No faucet holes; requires wall- or counter-mount faucet
- Iron Gate painted underside

Material

- KOHLER® enameled cast iron.

Installation

- Vessel, drop-in, or under-mount



ADA

CSA B651

OBC

Codes/Standards

ASME A112.19.1/CSA B45.2

ADA

ICC/ANSI A117.1

CSA B651











OBC

Lifetime Limited Warranty for KOHLER® Cast Iron Components

See website for detailed warranty information.

Available Color/Finishes

Color tiles intended for reference only.

Color	Code	Description
	0	White
	FF	Sea Salt™
	96	Biscuit
	FD	Cane Sugar™
	NY	Dune
	G9	Sandbar
	K4	Cashmere
	FT	Basalt
	20	Suede
	KA	Black 'n Tan
	7	Black Black™

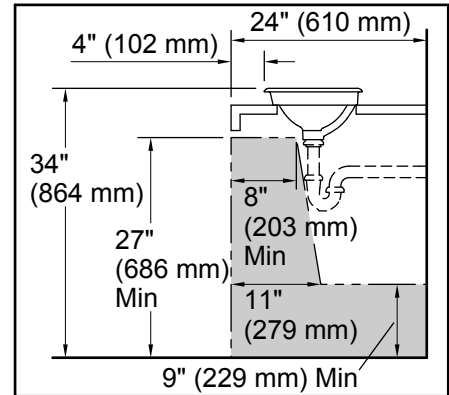
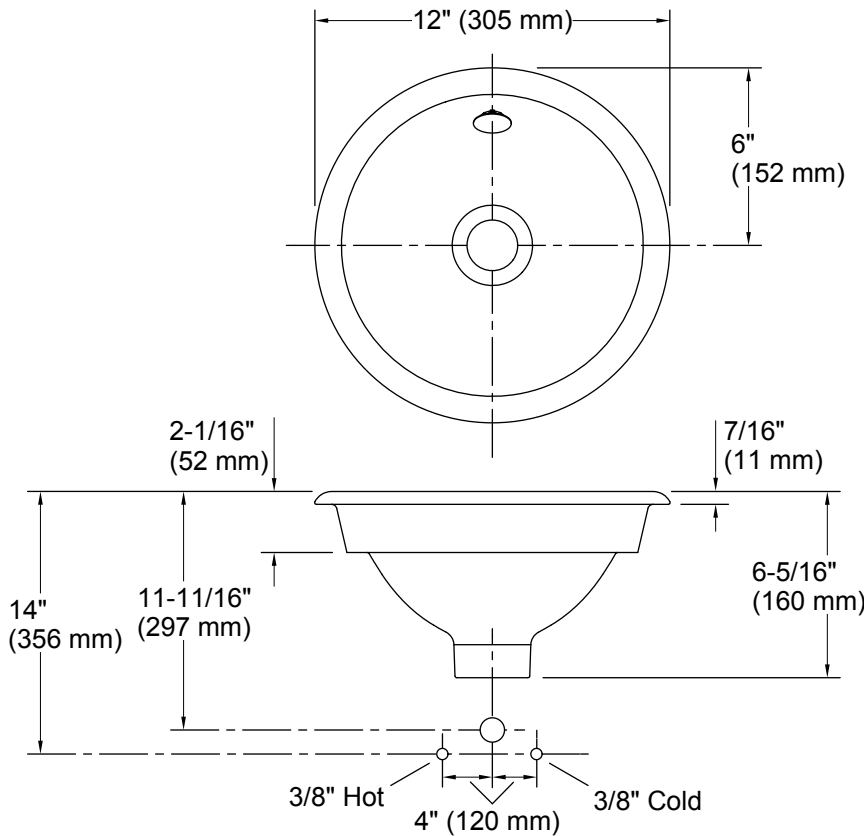

Recommended ADA Installation

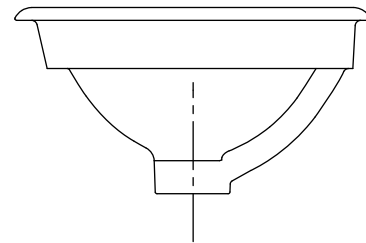

Technical Information

All product dimensions are nominal.

Installation: Drop-In, Under-mount, Vessel

Drain hole: 1-3/4" (44 mm)

Template: 1319047-7, required, included

Notes

Install this product according to the installation instructions.

NOTICE: Countertop manufacturer or cutter must use the cut-out template provided with the product, or a current one provided by Kohler Co. (call 1-800-4-KOHLER). Kohler Co. is not responsible for cutout errors when the incorrect cut-out template is used.

ADA, OBC, CSA B651 compliant when installed to the specific requirements of these regulations.