



ONCE UPON A TIME...WATER®

BF1599 CalGreen 3-way 1/2" diverter and Decorative Trim

SPECIFICATIONS

Features

- Solid brass construction
- No visible screw
- Male water inlet 1/2NPT threaded or welded
- Total adjustment of 19 mm (3/4")
- Support for better stability during installation included
- Operates 1 component at a time

Colors (Finishes)

- Chrome: BF1599-110
- Brushed nickel PVD: BF1599-120

Certifications

The specified model meets or exceeds the following standards;



Packaging

- **Dimensions :**
315 mm x 125 mm x 115 mm
(12 3/8" x 4 7/8" x 4 1/2")
- **Volume:** 0.004 cu m (0.16 cu ft)
- **Total weight:** 1.3 kg (2.87 lb)

Maximum flow rate

- 1 outlet: 22 liters/min.
(5.8 gallons/min.) at 60 psi

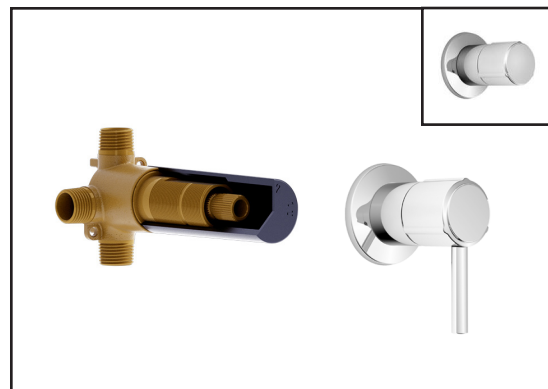

Installation Notes

This product must be installed following the installation instructions provided.

WARRANTY

Kalia Inc. guarantees all aspects of its products to be free of defects in material and workmanship for normal residential use. **Refer to the warranty included with the Kalia products for details.**

Product dimensions:

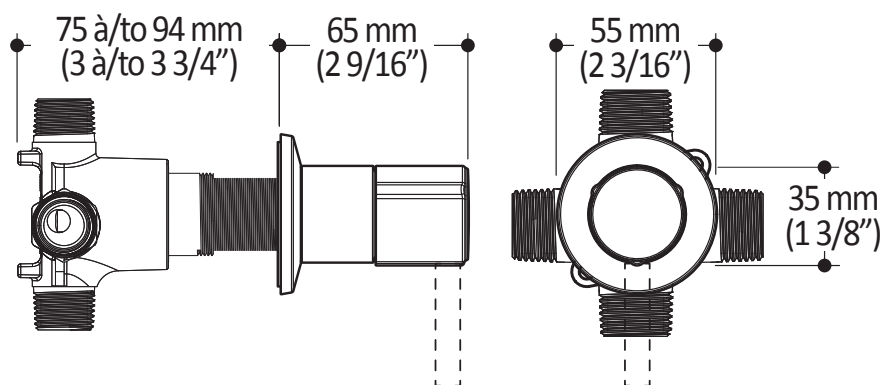

Important: Dimensions are approximated and are subject to changes. Please refer to the installation instructions.

Configuration 3 voies (CalGreen)

3-way configuration (CalGreen)

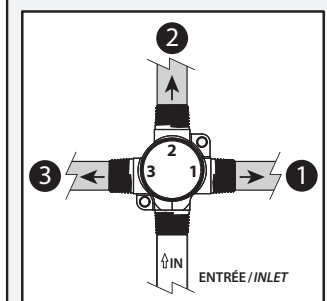
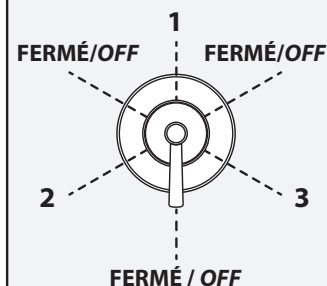

ONCE UPON A TIME...WATER®

1355, 2nd Street, Industrial Park
Sainte-Marie (Québec)
Canada G6E 1G9

T 418-387-9090
1-877-GO-KALIA (1-87- 465-2542)
F 418 387-9089

KaliaStyle.com

