

Plan
1491607000 Towel hook

PRODUCT

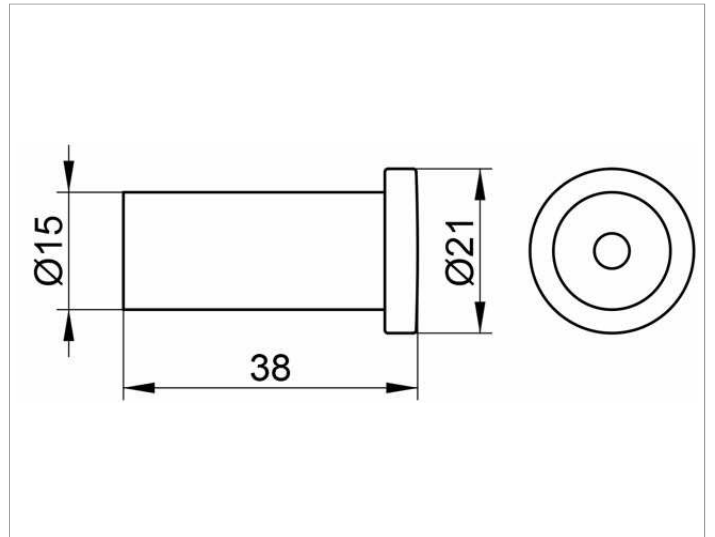

DRAWING



SURFACE

stainless steel

DIMENSION

38 mm

SPECIFICATIONS

KEUCO PLAN towel hook 14916070000

A classic towel hook in high grade stainless steel, in a stylish yet functional design

Cylindrical form with rounded edges, easy to clean

Depth 38 mm, diameter of cylinder 15 mm, diameter of head 21 mm

The towel hook is fitted with 1 hidden fixing point

incl. corrosion-free mounting material