

MILAN COLLECTION APPLIANCE PULLS 18" 254918

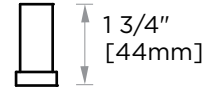
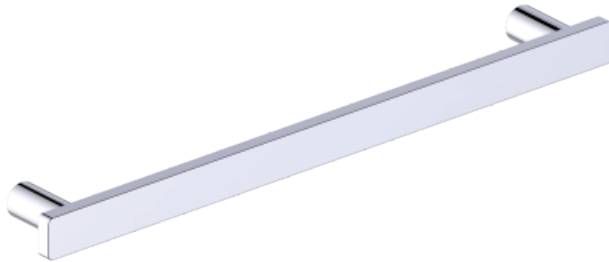

PRODUCT NAME: APPLIANCE PULLS 18"

PRODUCT CODE: 254918

MATERIAL: All-brass construction

KEY FEATURES: Contemporary design. Clean linear statement combined with engineered curves.

STOCKED FINISHES:

- Polished Chrome (99)
- Brushed Nickel (81)
- Polished Nickel (68)

SPECIAL FINISHES AVAILABLE: 26 options available. Please see our website for full list samples

WARRANTY:
Lifetime Limited (Residential Use)
One Year (Commercial Use)

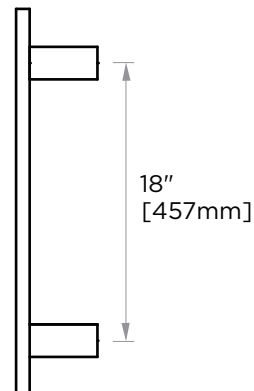
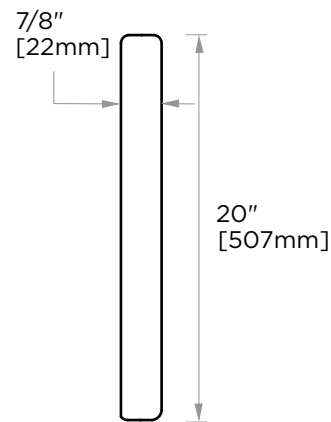

NOTE: Dimensions and specifications are subject to change without notice.