

025807 | J18[®]

UNDERMOUNT KITCHEN SINK

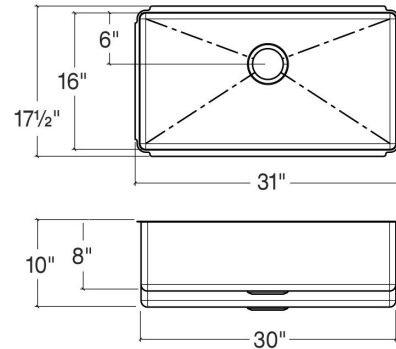

Specifications

Model	025807
Collection	J18 [®]
Bowl dimensions	30" × 16" × 8"
Overall dimensions	31 1/2" × 17 1/2" × 8"
Recommended cabinet	36"

Recommended accessories

Drain	100080
Grid	200307
Grid (coming soon)	200909
Colander	205223
Bin	205226
Tray	205232
Cutting board	210063
Drying Rack	215206

Warranty

Home Refinements offers a LIMITED LIFETIME WARRANTY on the fixed components of its stainless steel sinks against defects of material and workmanship. For further details on our product warranty, please refer to our catalog or Web site.

Features

- Handcrafted in Canada
- Residential quality stainless steel - 18 ga thickness
- Corrosion resistant material - 304 series (18/10)
- Environmentally friendly product, 100% recyclable
- Elegant no. 4 brushed finish that matches the appliances
- Highly efficient sound deadening pads
- Practical flat sink bottom and straight bowl sides that maximize available space in the bowl
- Stylish and functional bowl bottom grooves that facilitate water drainage
- Rear 3-1/2" drain placement
- Mounting hardware and cutout template included
- Certifications: ASME A112.19.3, CSA B45.0, CSA B45.4