

TEE - YELLOW BRASS PIPE FITTINGS

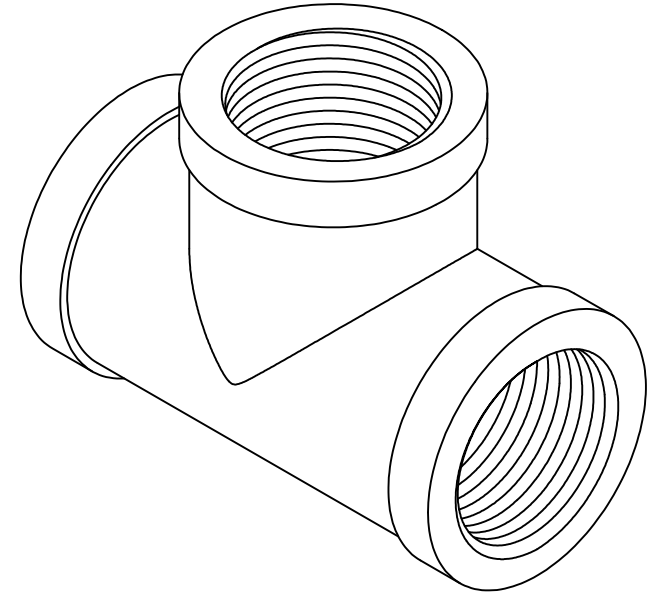
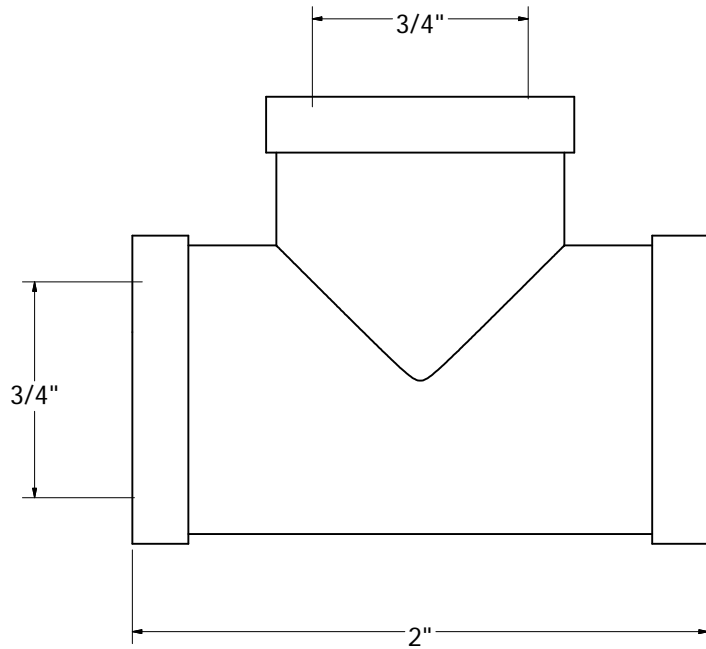
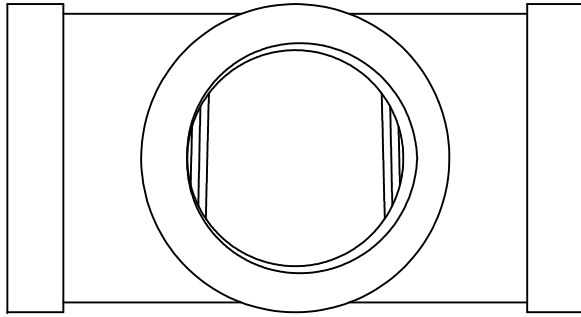

PHONE NUMBER
1-800-355-6637
 FAX NUMBER
1-800-462-6991
 SCALE _____ DATE _____
 SHEET
1 OF 1
 DRAWN BY
ASHLEY KRALOVEC

PART NO.

P10018

IPT

1/2"

CTN/MSTR

1