

**Amberly Vanity Series: 670-V30-WLT**  
**Assembly / Installation Instructions**

**Important Notes:**

This vanity cabinet may be used freestanding, or may be mounted to a wall (floating).  
If you are using this cabinet as a freestanding unit, please refer to pages 02- 05.

If you are using this cabinet as a wall mounted (floating) unit, please refer to pages 01 - 05.

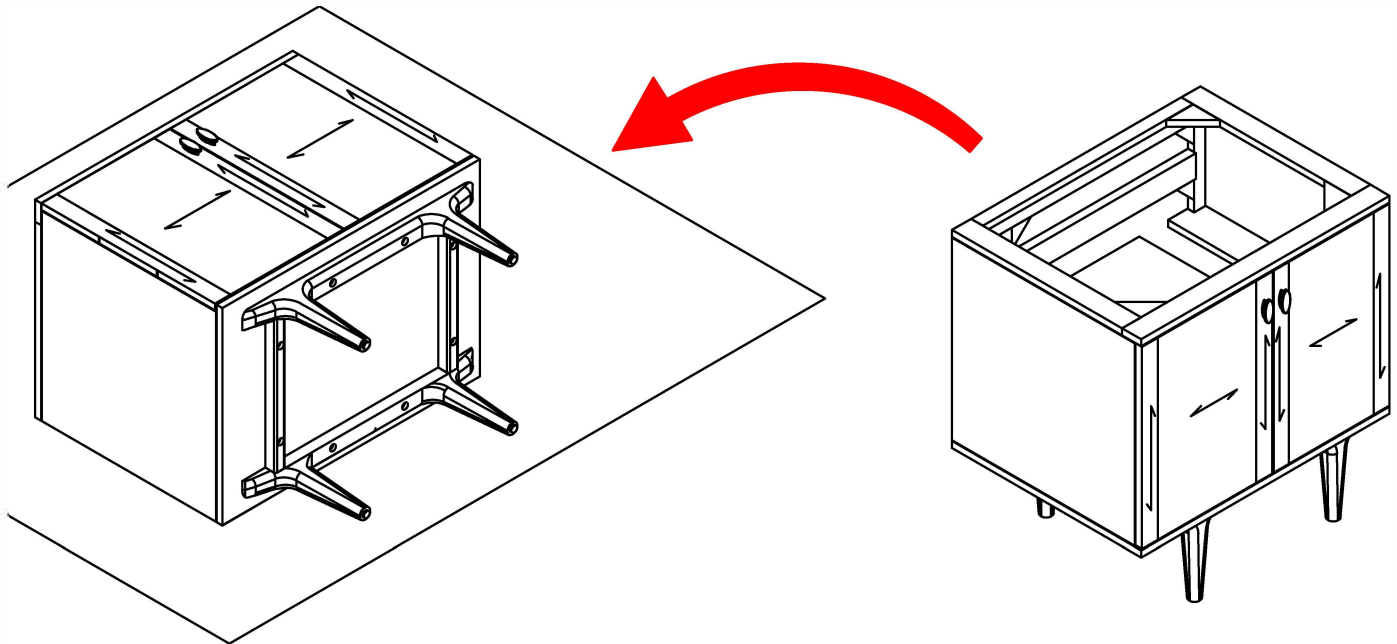

**Step 1 Notes:**

To prepare the cabinet for wall mounting, you need to remove the attached wooden base.  
Please place a blanket or other soft material on the floor and then place the cabinet on its back.

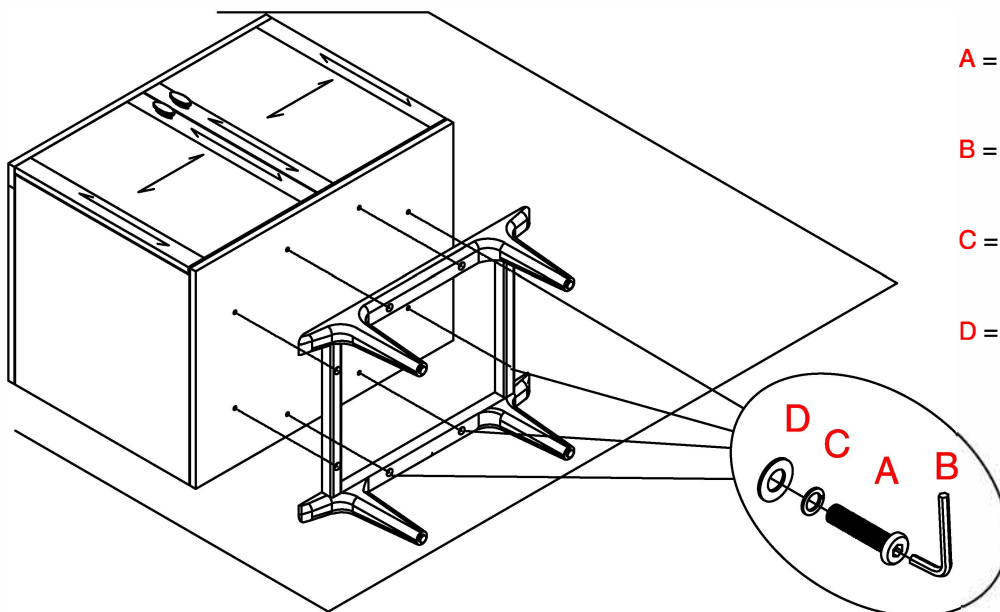

**A** = 8 pcs bolt 1/4" x 1-1/2"



**B** = 1 pc allen wrench #04



**C** = 8 pcs spring washer 1/4"



**D** = 8 pcs flat washer 1/4"x5/8"



**Step 2 Notes:**

Please locate the red hardware bag which is included with the cabinet.  
You will need the hex key (allen) wrench to remove the bolts and washers from the base.  
Please keep the removed hardware and wrench for possible use in the future.

### Amberly Vanity Series: 670-V30-WLT

#### Assembly / Installation Instructions

#### Materials for Installation:

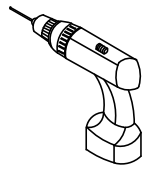

Drill

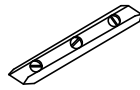

Level

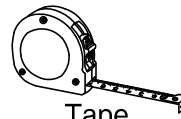

Tape Measuring



Pencil



Stud Finder

#### F Pre-attached metal mounting (French Cleat) bracket

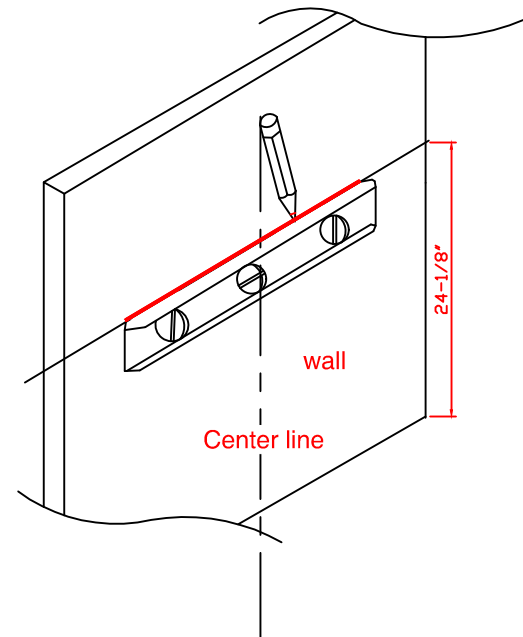
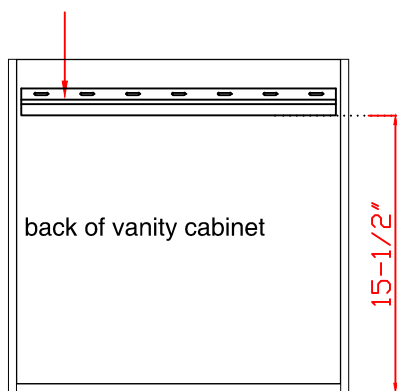

#### Step 3 Notes:

The metal mounting brackets has been pre-installed to the backside of the cabinet 15 1/2" from the bottom of the cabinet, remove one piece from the back of the cabinet .

#### Step 4 Notes:

Draw a horizontal line on the wall at your desired height. For this cabinet, most people use a height of 24 1/8"

#### Step 5 Notes:

Locate and mark the position of the wall's interior studs to which you will fasten the metal bracket. We recommend the use of an electronic stud finder to locate the studs.

(Alternately, you may find studs by listening for a solid sound as you knock on the wall)

#### Special Note 1:

If the studs in your bathroom do not line up to the mounting location for your vanity, additional wood blocking can be installed between the studs using standard 2 x 4 lumber.

#### Special Note 2:

Due to the narrow width of this cabinet, you may decide to use dry wall anchors if the wall studs are not spaced appropriately.

#### IMPORTANT:

James Martin Vanities recommended you always consult with professional installers and contractors regarding the correct installation of our products.

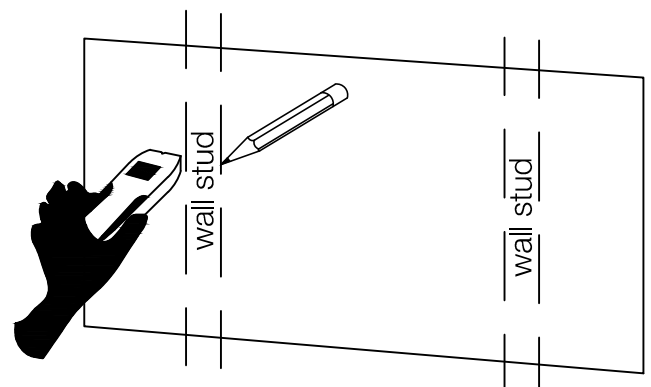

Amberly Vanity Series: 670-V30-WLT  
Assembly / Installation Instructions

**Materials  
for  
Installation:**

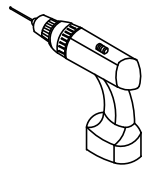

Drill



Pencil



Hammer

**E**=7PCS Drywall Anchor Ø8\*38mm



**F**=1PC Metal Brackett 700mm



**G**=7PCS Screws Ø4\*40mm

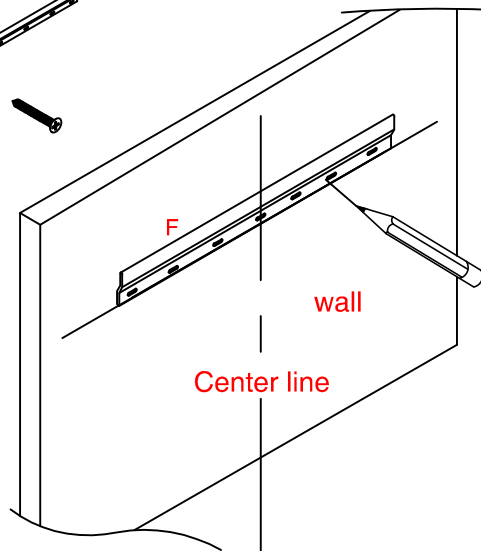

**Step 6 Notes:**

After you have located the wall studs, position the metal bracket so the holes align with the center points of the studs. Mark these positions with a pencil.

**Step 7 Notes:**

Drill holes for the screws in the positions you have marked with the pencil. Drill the holes' depth no less than 1 1/2", insert "E" to the holes by using hammer.

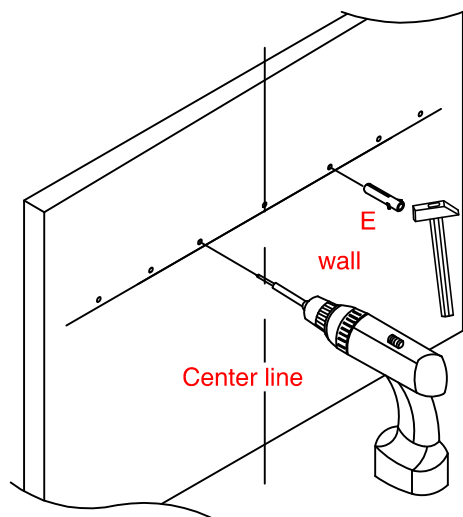

Amberly Vanity Series: 670-V30-WLT  
Assembly / Installation Instructions

**Materials  
for  
Installation:**

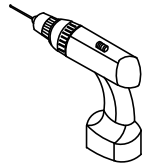

Drill

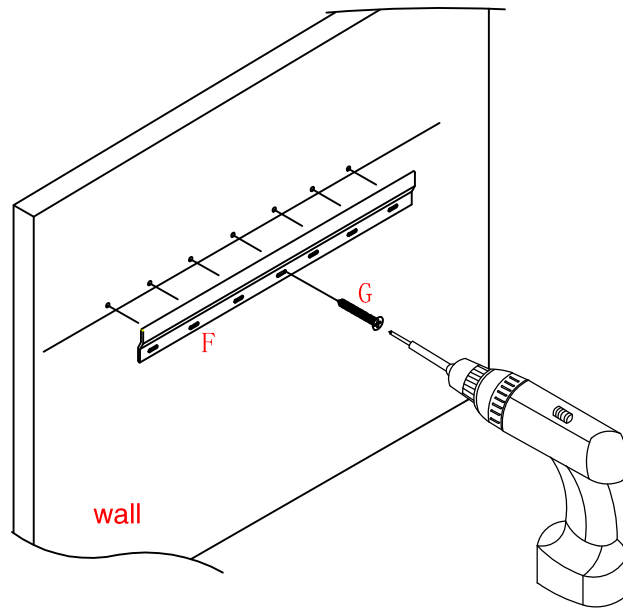

**Step 8 Notes:**

Attach the metal bracket to the wall using the screws "G" included in the red hardware bag.

**Step 9 Notes:**

Hang the cabinet on the metal bracket.

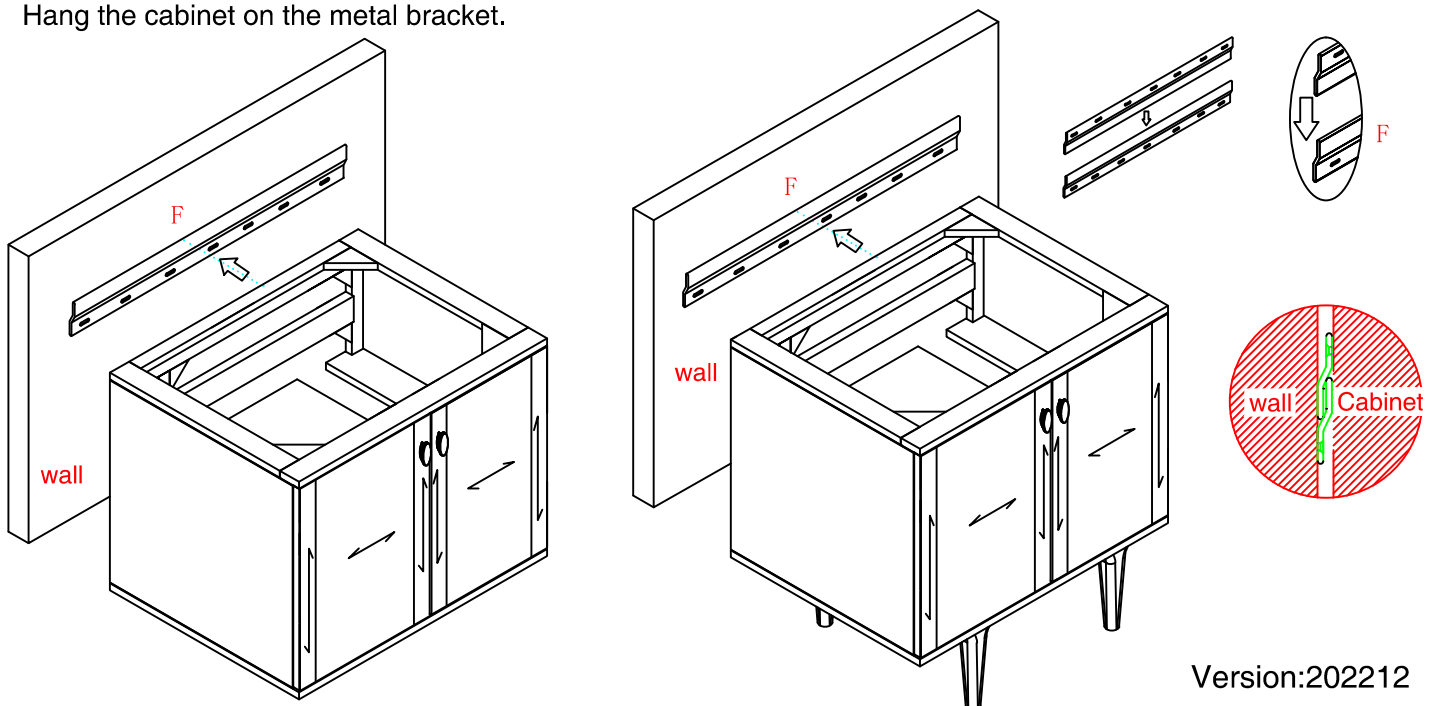

Amberly Vanity Series: 670-V30-WLT  
Assembly / Installation Instructions

**Materials  
for  
Installation:**

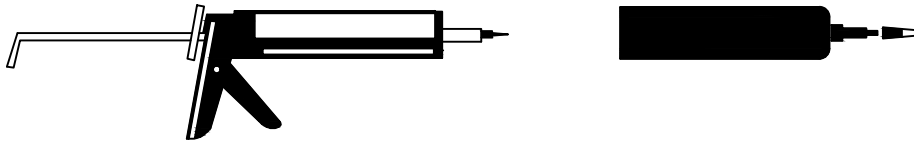

**Step 10 Notes:**

Properly align and secure the countertop to the cabinet with high quality adhesive.

