

30" Retrofit Wall Bar with Adjustable Mounts

Model #: 9730-



FEATURES:

- 30" Brass universal fit wall bar
- Adjustable height & angle
- Adjustable mounts to fit pre existing holes, no need to re-tile or patch walls. Mounts can adjust to cover holes.
- Lever adjustment for easy movement of slider up & down & side to side
- 180° handshower angle adjustment
- Conical end of hose sits in holder
- Mounting hardware included
- CLSD-95 soap dish for wall bar sold separately
- Oversized escutcheons available to cover large existing holes. Contact JACLO.

AVAILABLE FINISHES:

Polished Chrome (PCH)	Satin Chrome (SC)	Bronze Umber (BU)
Satin Nickel (SN)	Pewter (PEW)	Caramel Bronze (CB)
Polished Nickel (PN)	Antique Brass (AB)	Antique Copper (ACU)
Oil-Rubbed Bronze (ORB)	Polished Brass (PB)	Polished Copper (PCU)
Vintage Bronze (VB)	Satin Brass (SB)	Matte Black (MBK)
Satin Gold (SG)	Polished Gold (PG)	Black Nickel (BKN)
Bombay Gold (BG)	Jewelers Gold (JG)	Europa Bronze (EB)
White (WH)	Sedona Beige (SDB)	Tristan Brass (TB)
Unlacquered Brass (ULB)	Satin Cooper (SCU)	

SPECIFICATION DRAWING:

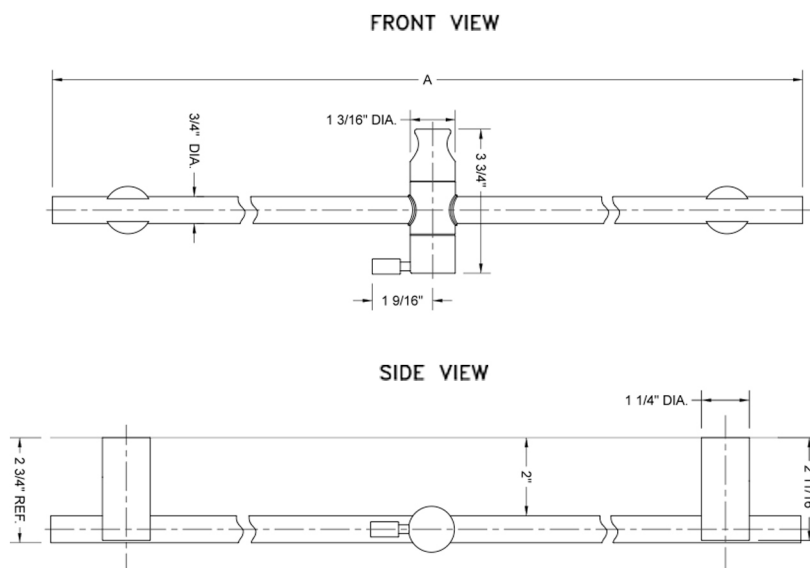

DECORATIVE WALL BAR		
PART. #	DESCRIPTION	A
9724	24" ADJ. WALL BAR	24"
9730	30" ADJ. WALL BAR	30"
9736	36" ADJ. WALL BAR	36"