

Extra Long Thread Round Toe Control Drain Strainer with Overflow- 3" Long Thread

Model #: 526-75-



FEATURES:

- 3" long threads for thick tubs
- Round brass cap (2 7/8" diameter)
- Brass body
- Fits JACLO, Gerber and most other manufacturers
- Use for thick tubs requiring drain with overflow

AVAILABLE FINISHES:

Polished Chrome (PCH)	Satin Chrome (SC)	Bronze Umber (BU)
Satin Nickel (SN)	Pewter (PEW)	Caramel Bronze (CB)
Polished Nickel (PN)	Antique Brass (AB)	Antique Copper (ACU)
Oil-Rubbed Bronze (ORB)	Polished Brass (PB)	Polished Copper (PCU)
Vintage Bronze (VB)	Satin Brass (SB)	Matte Black (MBK)
Satin Gold (SG)	Polished Gold (PG)	Black Nickel (BKN)
Bombay Gold (BG)	Jewelers Gold (JG)	Europa Bronze (EB)
White (WH)	Sedona Beige (SDB)	Tristan Brass (TB)
Unlacquered Brass (ULB)	Satin Cooper (SCU)	

SPECIFICATION DRAWING:

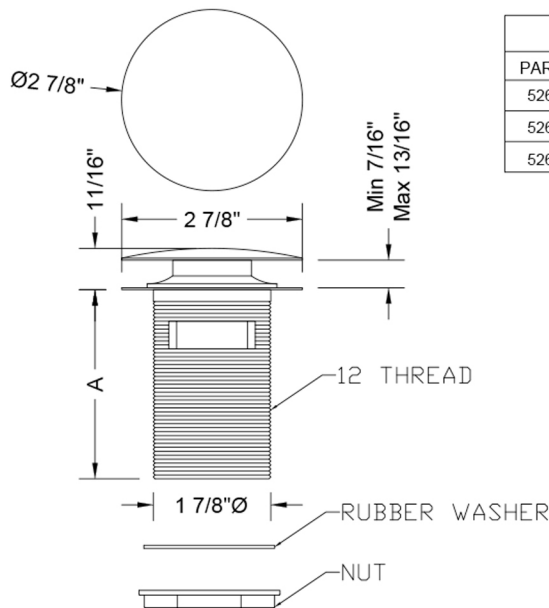

BRASS ROUND TOE-CONTROL DRAIN STRAINER		
PART. #	DESCRIPTION	A
526-75-	EXTRA LONG TOE-CONTROL DRAIN STRAINER	3"
526-100-	EXTRA LONG TOE-CONTROL DRAIN STRAINER	4"
526-125-	EXTRA LONG TOE-CONTROL DRAIN STRAINER	5"