

## 32" Deluxe Grab Bar with Traditional Round Flange

**Model #: 2532-**



### FEATURES:

- ADA compliant when properly installed
- Complements Roaring 20's, Westfield, Cranford, Jaylen & Astor collections
- Covers standard 3" flange on stainless steel grab bars
- No need to re-tile in retro-fit applications
- 1 1/4" diameter
- 32" center post to center post
- For large quantity custom lengths contact [hospitality@jaclo.com](mailto:hospitality@jaclo.com)

### AVAILABLE FINISHES:

Polished Chrome (PCH)	Satin Chrome (SC)	Bronze Umber (BU)
Satin Nickel (SN)	Pewter (PEW)	Caramel Bronze (CB)
Polished Nickel (PN)	Antique Brass (AB)	Antique Copper (ACU)
Oil-Rubbed Bronze (ORB)	Polished Brass (PB)	Polished Copper (PCU)
Vintage Bronze (VB)	Satin Brass (SB)	Matte Black (MBK)
Satin Gold (SG)	Polished Gold (PG)	Black Nickel (BKN)
Bombay Gold (BG)	Jewelers Gold (JG)	Europa Bronze (EB)
White (WH)	Sedona Beige (SDB)	Tristan Brass (TB)
Unlacquered Brass (ULB)	Satin Cooper (SCU)	

### SPECIFICATION DRAWING:

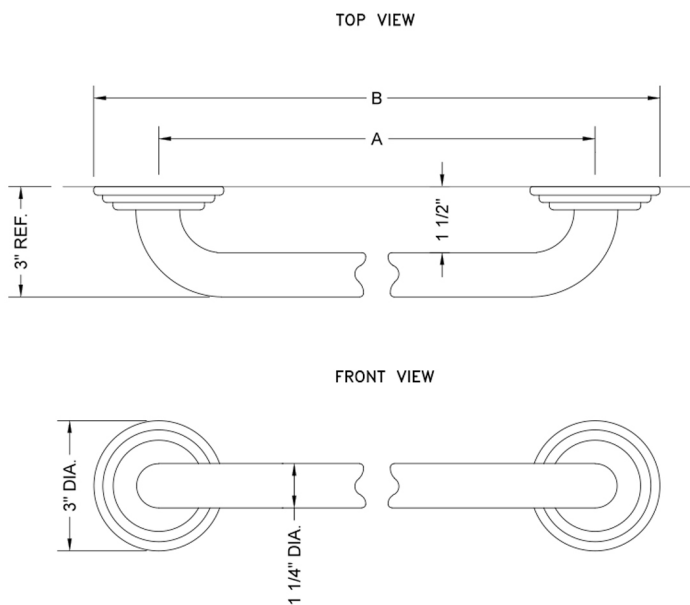

GRAB BAR W/ TRADITIONAL ROUND FLANGE			
PART. #	DESCRIPTION	A	B
2512	12" GRAB BAR	12"	15"
2516	16" GRAB BAR	16"	19"
2518	18" GRAB BAR	18"	21"
2524	24" GRAB BAR	24"	27"
2532	32" GRAB BAR	32"	35"
2536	36" GRAB BAR	36"	39"
2542	42" GRAB BAR	42"	45"
2548	48" GRAB BAR	48"	51"