

230.7350 | Two Output Shower W/ Rain Head , Hand Held & Slide Bar

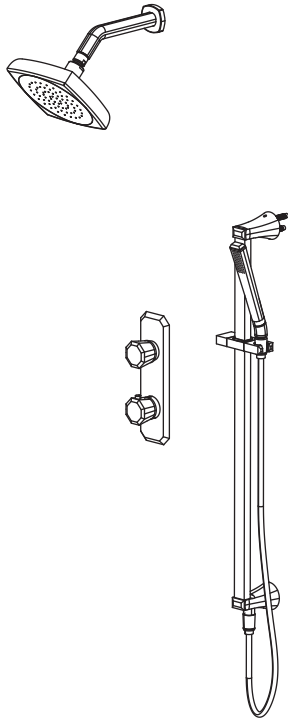

COMPONENTS

- RHW.7C - 7" Head w/8" Arm
- 230.4000VT - Shower Trim
- TVH.2717F - Shower Valve
- HS1029H - Hand Held
- 230.601005A - Slide Bar
- SP.150EM - 1.5m Hose

SHOWER VALVE:

- Thermostatic shower valve
- Valve includes service stops
- Turn bottom handle to set temp.
- Top handle controls water diversion
- Includes 15109 non-shared cartridge

SHOWER HEAD:

- Solid brass construction
- 1.8 GPM flow rate

STANDARDS:

- ASME A112.18.1 / CSA B125.1

See individual component specification sheets on following pages for further details.



RHW.7C | 7" Brass Shower Head With 8" Wall Mount Shower Arm

SPECIFICATIONS:

- Solid Brass construction
- With Swivel action
- Shower arm has sliding flange

STANDARDS:

- ASME A112.18.1 / CSA B125.1

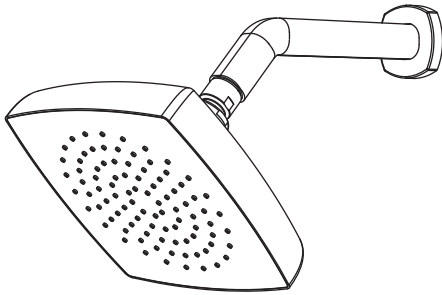

Legislation Compliance



ZeroDrip Technology



Technical Diagram

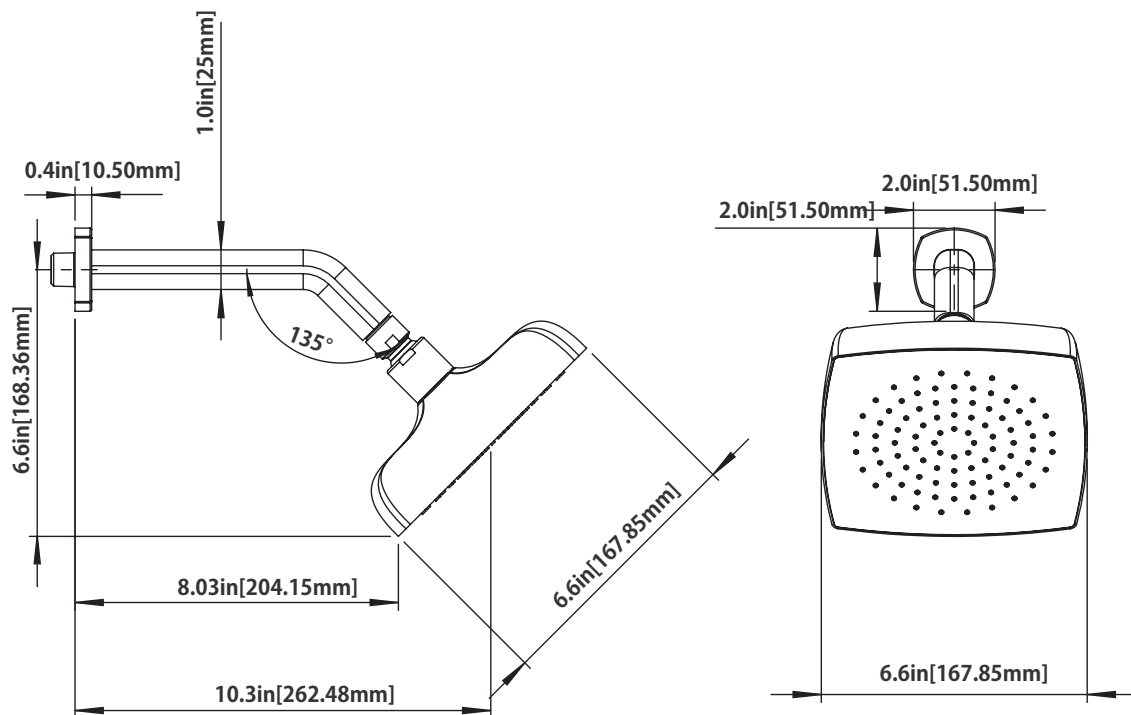

230.4000VT | Vertical Thermostatic Shower Trim

SPECIFICATIONS:

- Solid Brass Construction
- Trim Only - Valve Not Included
- Turn bottom handle to control temperature
- Turn top handle to control volume

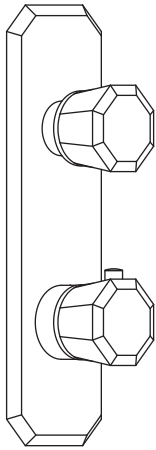

Belgian Mirror Finish



Legislation Compliance



ZeroDrip Technology



Technical Diagram

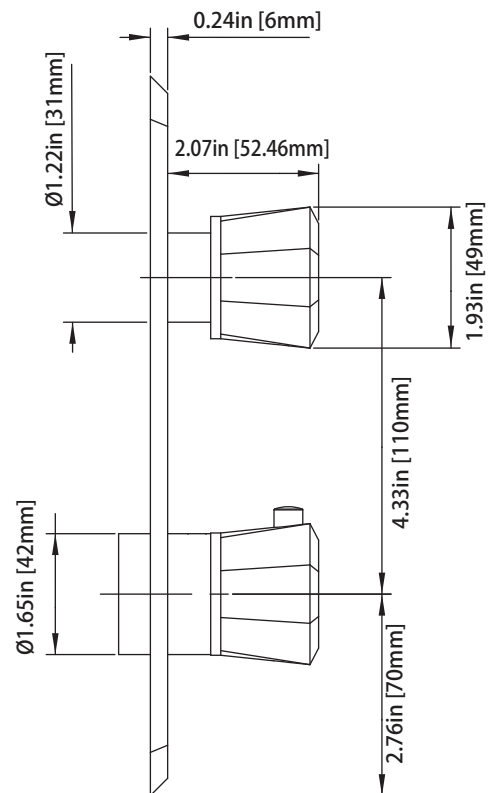
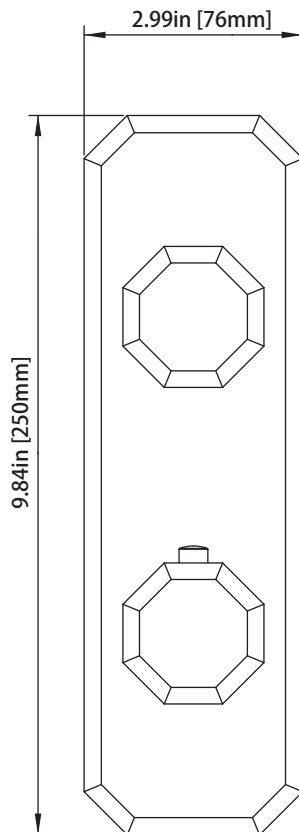



TVH.2717F | 3/4" Thermostatic Valve With 2-Way Diverter & Integrated Volume Control Page 1 of 2

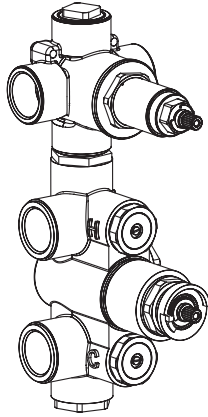

SPECIFICATIONS:

- Turn bottom knob to control temperature.
- Turn top knob to control water flow.
- Thermostatic Valve Flow Rate - 8.0 GPM @ 60 PSI
- Extension Available - TVH.4101E**

STANDARDS:

- ASME A112.18.1 / CSA B125.1

! A separate volume control is **not** needed to turn water supply off. Volume control functionality is integrated within this valve.

CALGreen Compliant



Legislation Compliance



ZeroDrip Technology



Technical Diagram

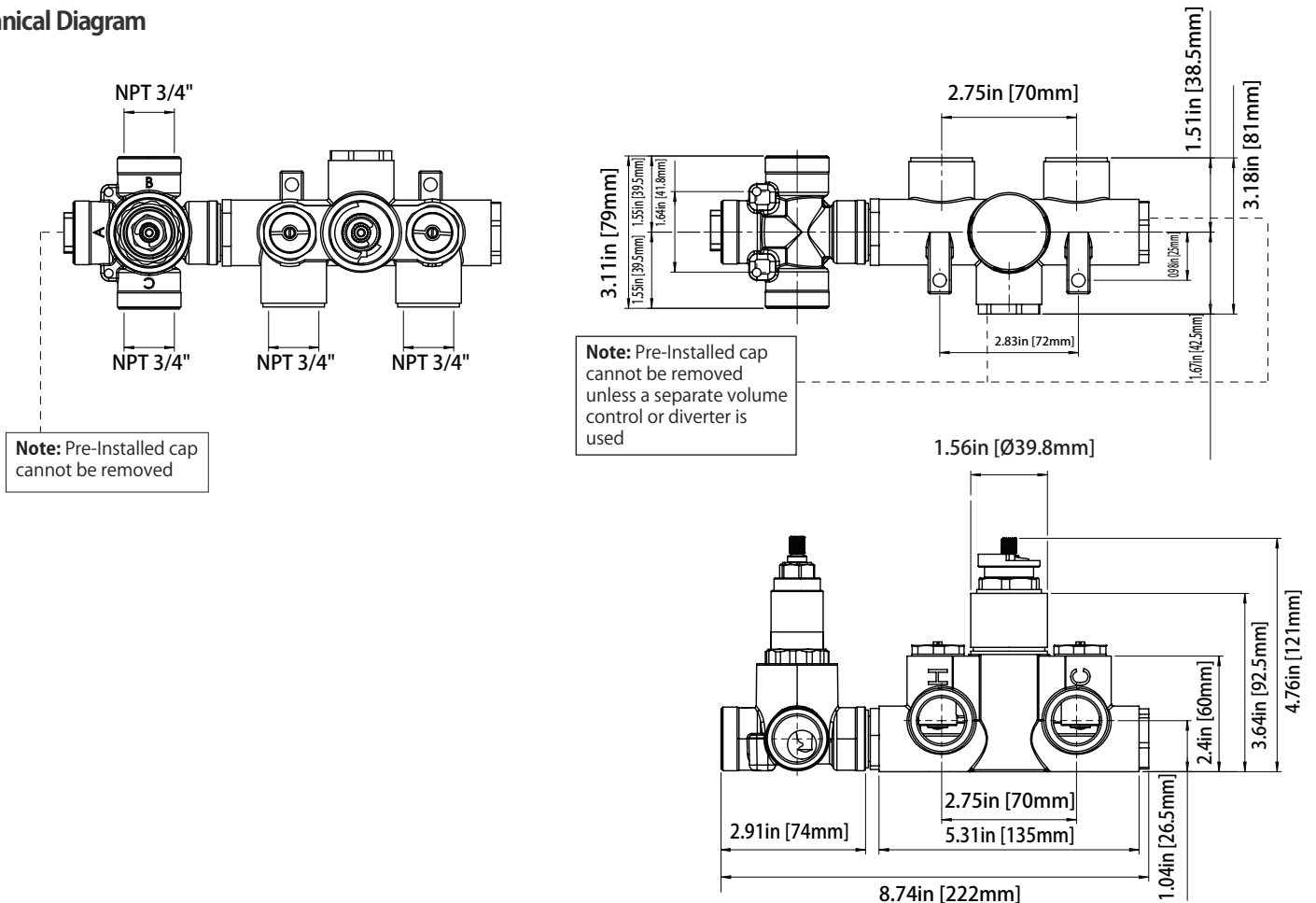

TVH.2717F | 3/4" Thermostatic Valve With 2-Way Diverter & Integrated
Volume Control Page 2 of 2



TWO OUTPUT - CAL-GREEN - NO SHARED PORT OPERATION

Diverter Cartridge # - **15109** (Included)

Total 3 Positions as defined below, with **only** 1 port active at one time.

- Position 0 - Off - No Water Flow
- Position 1 - Output B Activated
- Position 2 - Output C Activated

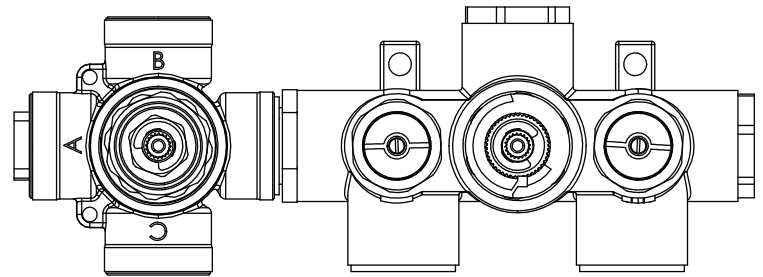

TWO OUTPUT - SHARED PORT OPERATION

Diverter Cartridge # - **15103** (Not Included)

Total 4 Positions as defined below, with 2 ports active at one time.

- Position 0 - Off - No Water Flow
- Position 1 - Output B Activated
- Position 2 - Output B+C Activated
- Position 3 - Output C Activated

HS1029H | Solid Brass Hand Shower

SPECIFICATIONS:

- Solid Brass Construction
- 1.8 GPM Flow Rate
- With back flow prevention check valve

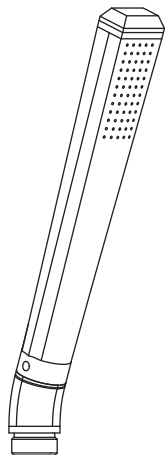

Legislation Compliance



ZeroDrip Technology



Technical Diagram

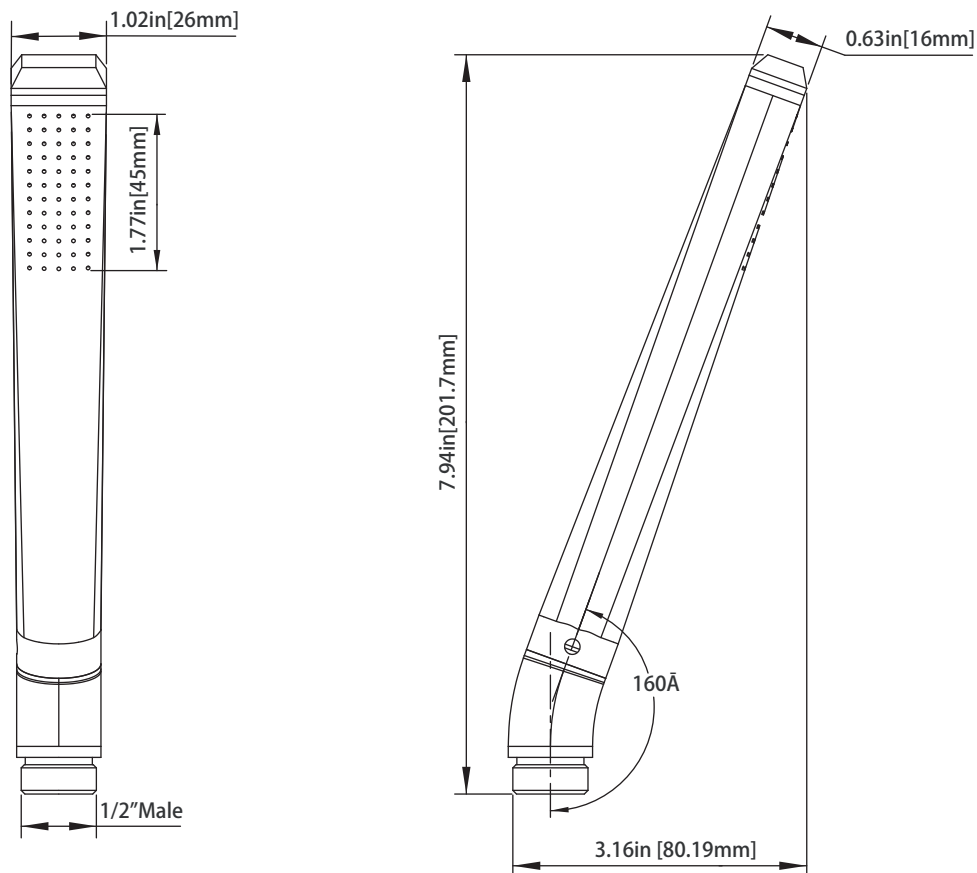

230.601005A | Slide Bar With Built in Supply Elbow

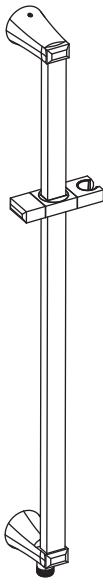

SPECIFICATIONS:

- With 1.8 GPM flow restrictor
- With backflow prevention check valve
- Adjustable slide on installation
- 1/2" female NPT connection
- Hand held shower height is adjustable
- Supply elbow is integrated into slide bar

Legislation Compliance



ZeroDrip Technology



Technical Diagram

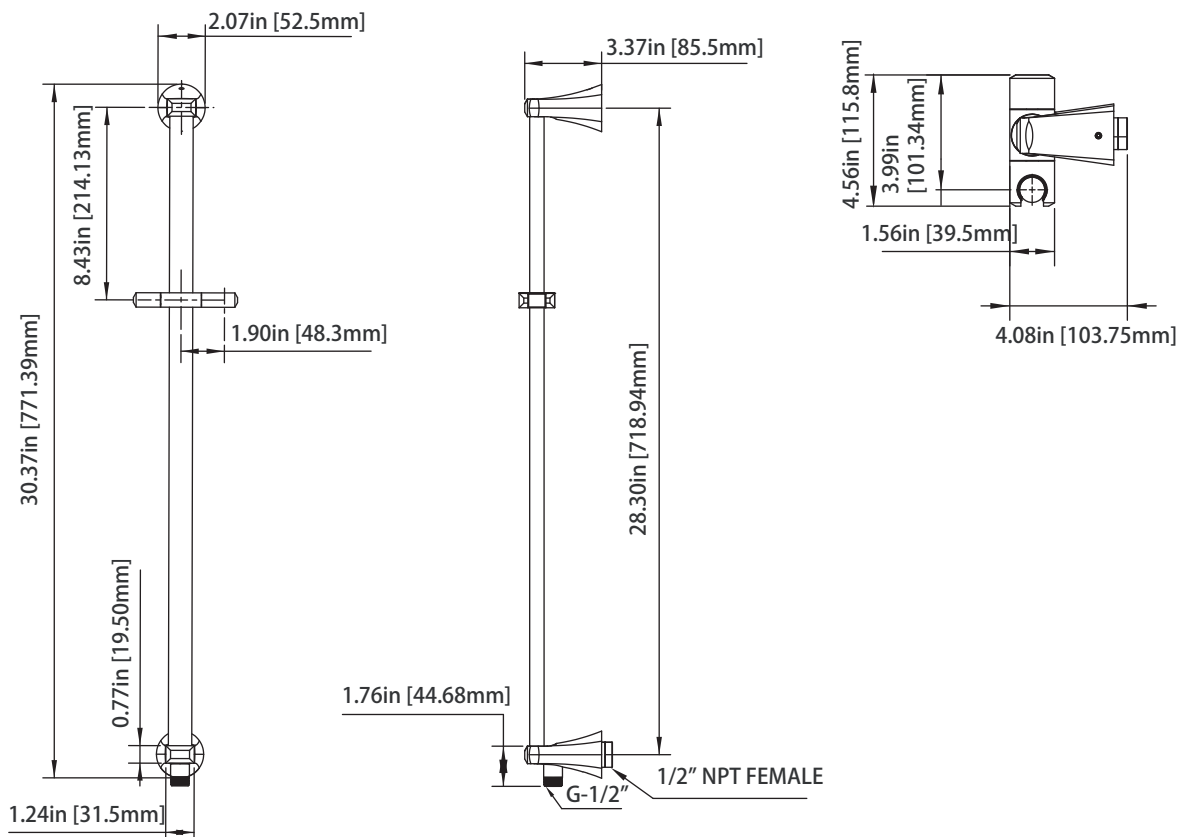

SP.150EM | Easy Maneuver Hose



SPECIFICATIONS:

- Stainless steel construction
- G-1/2" connection
- 1.5m length

Legislation Compliance



ZeroDrip Technology



Technical Diagram

