



145.4201 | 3/4" Thermostatic Valve With Trim

SPECIFICATIONS:

- Turn Handle to control temperature.
- Includes Thermostatic valve (TVH.4201) w/ service stops
- Thermostatic Valve Flow Rate - 13.0 GPM @ 60 PSI
- Extension Available - TVH.E185E**

STANDARDS:

- ASME A112.18.1 / CSA B125.1

FAST SHIP FINISHES :

- Chrome - 145.4201CP

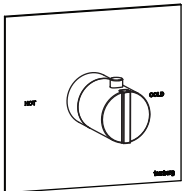

+



Trim
[145.4201T**]

Valve
[TVH.4201]

** Denotes Finish (CP, BN, etc.)

Belgian Mirror Finish



Legislation Compliance



ZeroDrip Technology



Technical Diagram

See Spec Sheet For
TVH.4201 For Detailed
Information On Valve.

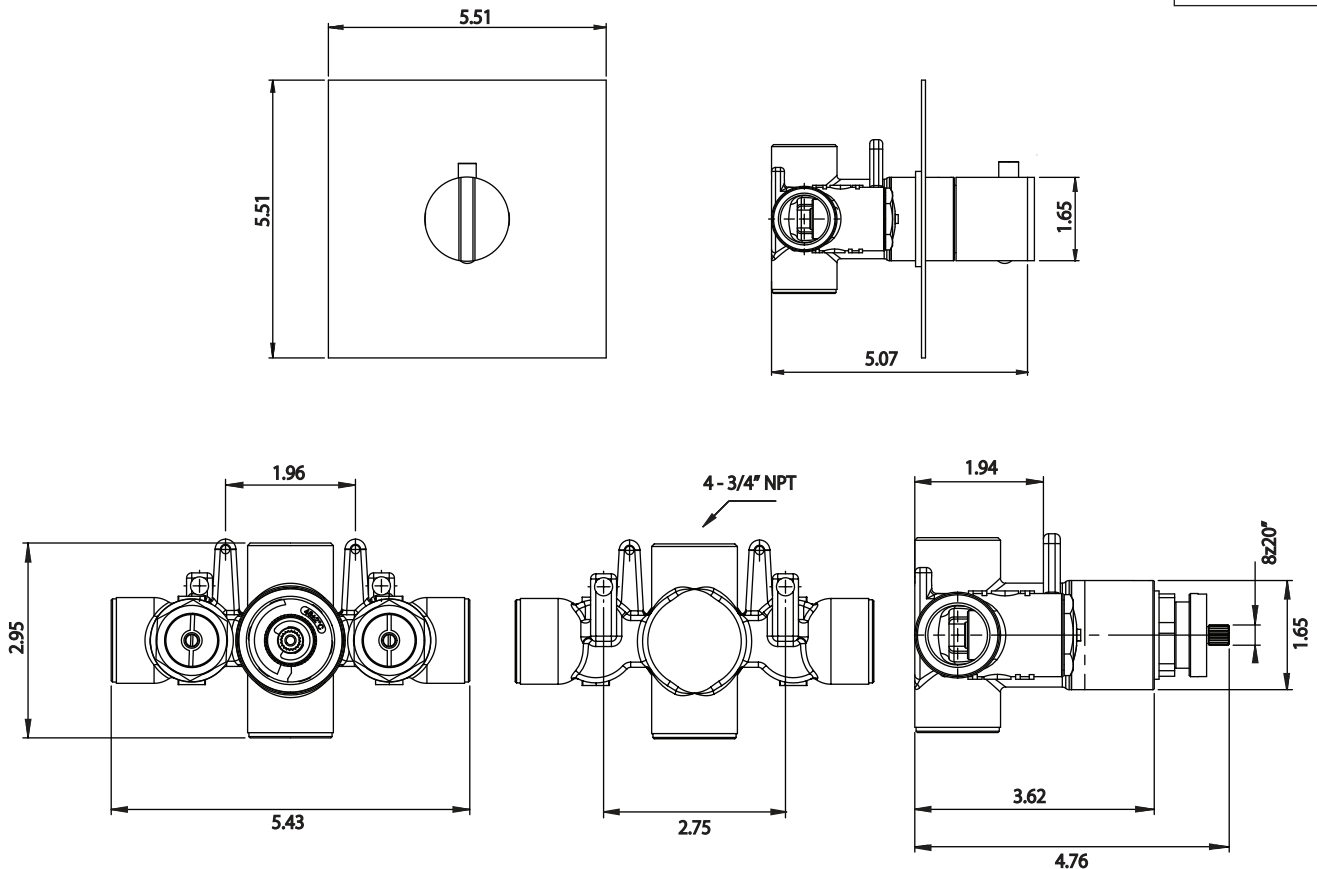

TVH.4201 | 3/4" Thermostatic Valve Page 1 of 2



SPECIFICATIONS:

- Turn knob to control temperature.
- Thermostatic Valve Flow Rate - 13.0 GPM @ 60 PSI

STANDARDS:

- ASME A112.18.1 / CSA B125.1

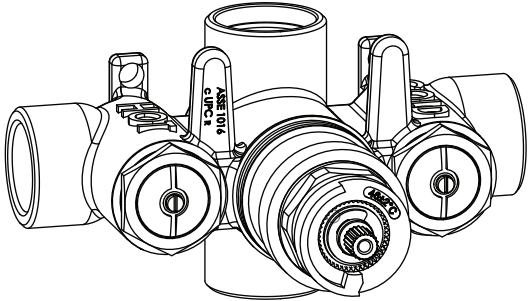

Legislation Compliance



ZeroDrip Technology



Technical Diagram

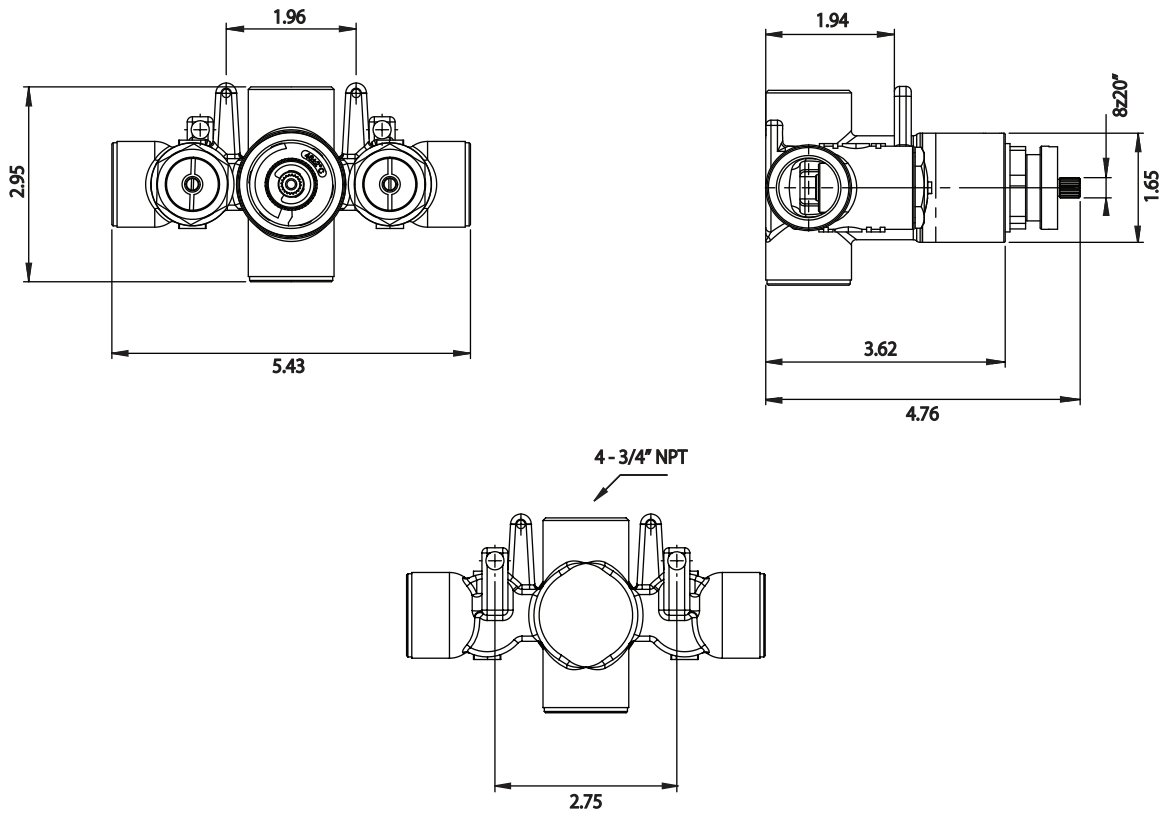

TVH.4201 | 3/4" Thermostatic Valve Page 2 of 2



Water Flow Diagram

