

HC 65 Specifications

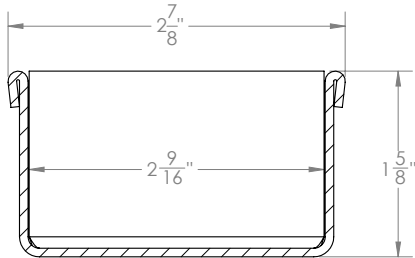

HC 65:

- Site Sizable Stainless Steel channel for the following models:
S-TIFAS 65/S-TIFAS 99 series drains
- Can be cut or extended on site.
- Stainless Steel channel designed to be used with HF 65/ HF 99 outlet section
- 2" threaded waste line connection via TNAS threaded outlet (included with channel)

Models (overall dimensions):

- HC 6532: 32" L x 2 7/8" W x 1 5/8" H
- HC 6540: 40" L x 2 7/8" W x 1 5/8" H
- HC 6552: 52" L x 2 7/8" W x 1 5/8" H
- HC 6572: 72" L x 2 7/8" W x 1 5/8" H
- HC 6588: 88" L x 2 7/8" W x 1 5/8" H

Finishes:

- Satin Stainless - SS
- Polished Stainless - PS
- Satin Bronze - SB
- Oil Rubbed Bronze - ORB
- Matte Black - BK

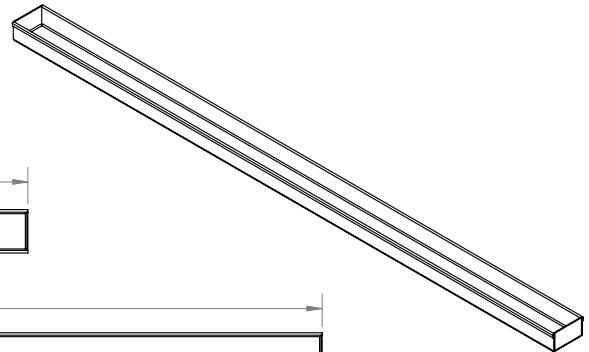
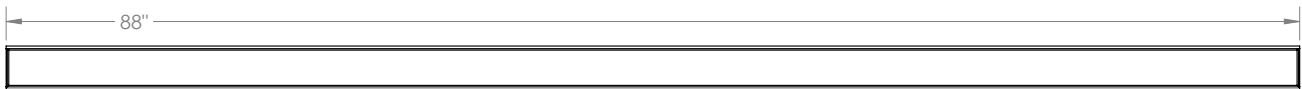
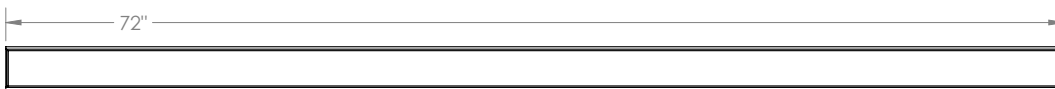
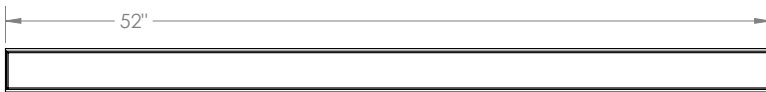
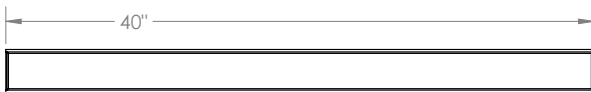
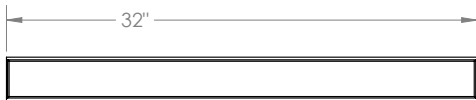

Infinity Drain
145 Dixon Avenue
Amityville, NY 11701
Phone: 516.767.6786
Fax: 516.740.3066
www.infinitydrain.com



NOTE: Installer must verify all rough-in dimensions prior to installation and consult local and national codes. Conformity and compliance to local and national codes are the responsibility of the installer.