

FFMN 65 Series Fixed Flange

- **FFMN 6532 - 32" Complete Kit**
- **FFMN 6536 - 36" Complete Kit**
- **FFMN 6542 - 42" Complete Kit**
- **FFMN 6548 - 48" Complete Kit**
- **FFMN 6560 - 60" Complete Kit**

Features

- Fixed flange with centered outlet location
- Indoor or outdoor use
- 16 gauge, 304L stainless steel grate and channel
- Pre - pitched channel
- Grate can be removed for cleaning
- NOT Site Sizable®
- Compatible with: liquid applied or fabric sheet membranes
- Flow rate - 9 gpm per outlet
 - Flow rate measured at outlet only. Measurement does not account for water in channel or sheeting on shower floor.
 - Additional outlets can be added and combined into a larger waste line to increase flow rates

Installation

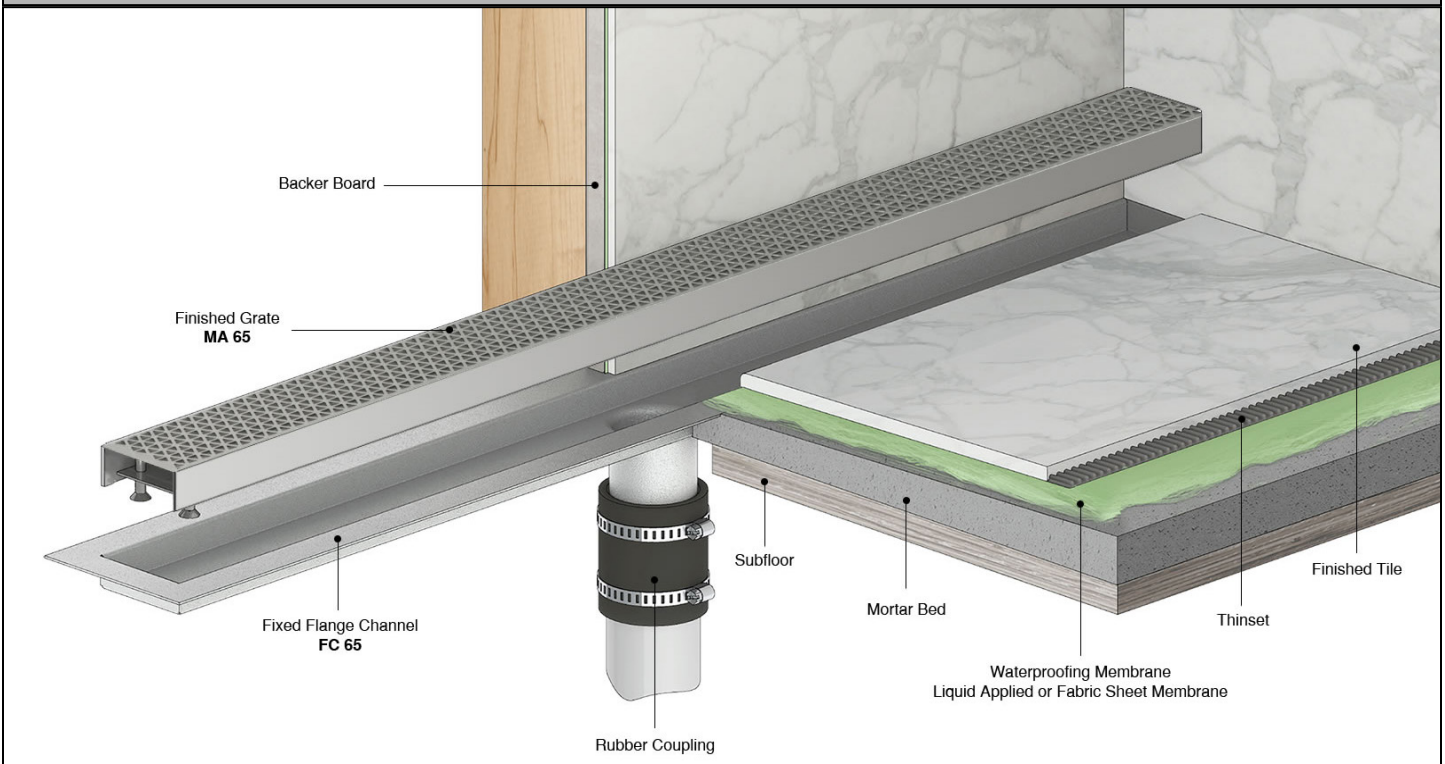

Care & Maintenance

FFMN 65 stainless steel linear drain top grates are made of 304L stainless steel. This material is non-porous, hygienic, rust-free and extremely durable. Bar Keepers Friend® and Soft Scrub® are commonly available products that can be used to protect and clean your Satin Stainless drain cover. For stains that have been left for an excessive amount of time, stronger cleaning agents such as Steel Brite® may be needed. For Polished Stainless and other finishes we recommend a mild soap and a soft cloth for cleaning. DO NOT use any abrasive cleaners, scrub pads or all household cleaning agents, such as bleach, to sit on the drain cover for a long period of time. Stainless steel does not rust. External factors, such as contamination from other highly ferrous metals, built up road salt, sea salt, or chlorine may have caused "surface" rust which can be removed using Barkeepers Friend®, Soft Scrub® with Bleach, or Steel Brite®. Always follow the directions on the bottle. Follow proper maintenance procedures to prevent excessive surface rust. In areas of frequent exposure to salt, chlorine, and other chemical compounds, maintenance of the stainless grates should be performed at least 2-3 times per year.

Infinity Drain
145 Dixon Avenue
Amityville, NY 11701
Phone: 516.767.6786
Fax: 516.740.3066
www.infinitydrain.com

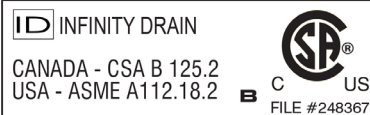

NOTE: Installer must verify all rough-in dimensions prior to installation and consult local and national codes. Conformity and compliance to local and national codes are the responsibility of the installer.

ID Infinity Drain®

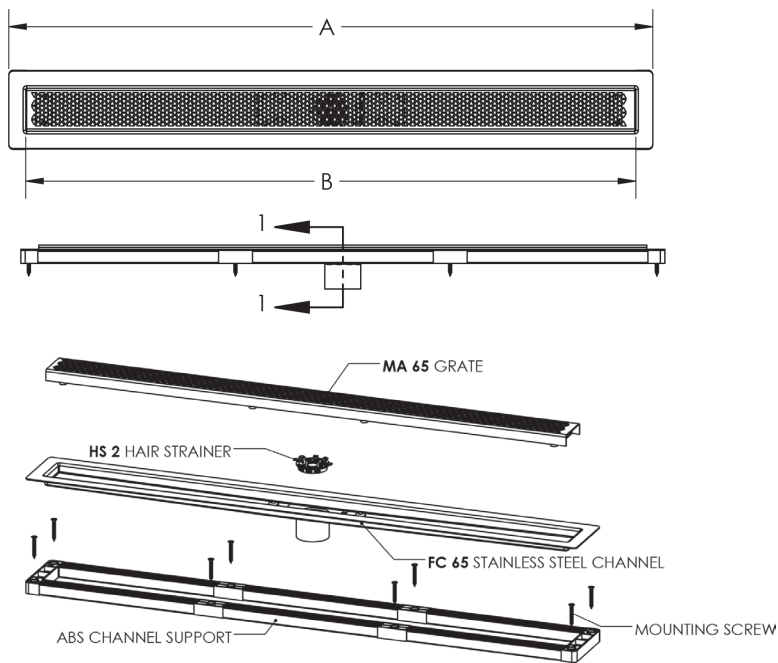

GRATE CAN BE ADJUSTED UPWARDS AN ADDITIONAL 1/2"

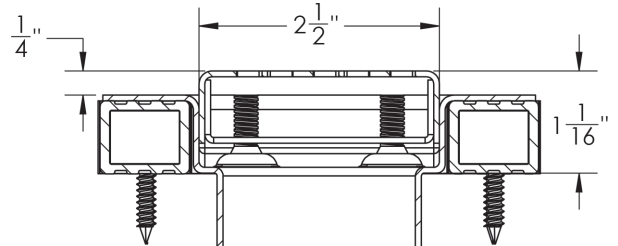

SECTION 1-1

Model Number	Complete Kit Contents	A (Maximum Overall Length)	B (Maximum Grate Length)
<input type="checkbox"/> FFMN 6532	1 - MA 6532 Grate 1 - FC 6532 Fixed Flange Channel 1 - HS 2 Hair Strainer 1 - DKEY Lift Out Key	34 1/8"	31 7/8"
<input type="checkbox"/> FFMN 6536	1 - MA 6536 Grate 1 - FC 6536 Fixed Flange Channel 1 - HS 2 Hair Strainer 1 - DKEY Lift Out Key	38 1/8"	35 7/8"
<input type="checkbox"/> FFMN 6542	1 - MA 6542 Grate 1 - FC 6542 Fixed Flange Channel 1 - HS 2 Hair Strainer 1 - DKEY Lift Out Key	44 1/8"	41 7/8"
<input type="checkbox"/> FFMN 6548	1 - MA 6548 Grate 1 - FC 6548 Fixed Flange Channel 1 - HS 2 Hair Strainer 1 - DKEY Lift Out Key	50 1/8"	47 7/8"
<input type="checkbox"/> FFMN 6560	1 - MA 6560 Grate 1 - FC 6560 Fixed Flange Channel 1 - HS 2 Hair Strainer 1 - DKEY Lift Out Key	62 1/8"	59 7/8"

Stock Finishes

Satin Stainless Polished Stainless Oil Rubbed Bronze Matte Black Matte White Satin Bronze

Infinity Drain
145 Dixon Avenue
Amityville, NY 11701
Phone: 516.767.6786
Fax: 516.740.3066
www.infinitydrain.com

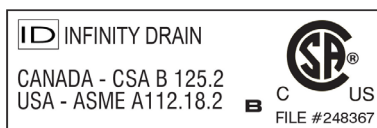

NOTE: Installer must verify all rough-in dimensions prior to installation and consult local and national codes. Conformity and compliance to local and national codes are the responsibility of the installer.

□ FFMN 65 CUSTOM

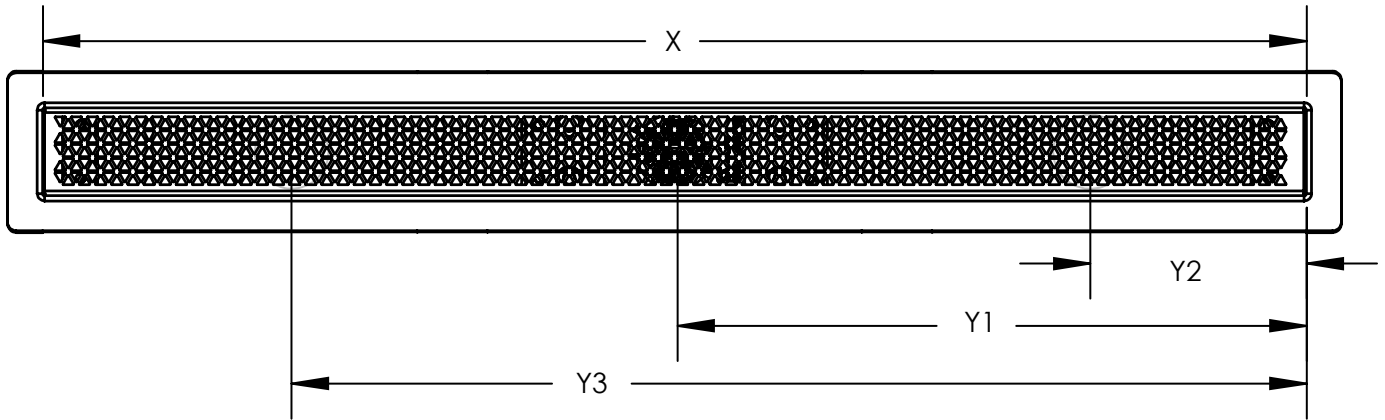

Custom Finishes

Satin Stainless
 Polished Stainless
 Oil Rubbed Bronze
 Matte Black
 Matte White
 Satin Bronze

NOTE: Custom color matching available upon request

X: LENGTH: Overall Inside Length of Channel (inches): _____

Desired finished dimension
 For lengths greater than 60", multiple grates are supplied, unless otherwise noted.

Y: OUTLET LOCATION: _____ # of outlets | Center of Outlet(s) to inside right edge: Y1 _____ Y2 _____ Y3 _____

RUSH: Yes _____ NO _____

Rush charge applied per set-up. Turnaround is 5 business days, plus shipping. (Rush does not apply to some custom designs, please contact Infinity Drain for details)

*ABS Channel Support not provided with custom orders

Customer: _____

Job Name: _____

Approved by: _____

Date: _____

Infinity Drain
 145 Dixon Avenue
 Amityville, NY 11701
 Phone: 516.767.6786
 Fax: 516.740.3066
 www.infinitydrain.com

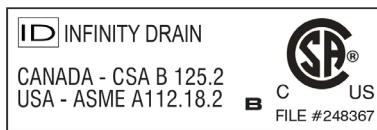

NOTE: Installer must verify all rough-in dimensions prior to installation and consult local and national codes. Conformity and compliance to local and national codes are the responsibility of the installer.