

iWash S-11 Electronic Bidet Seat

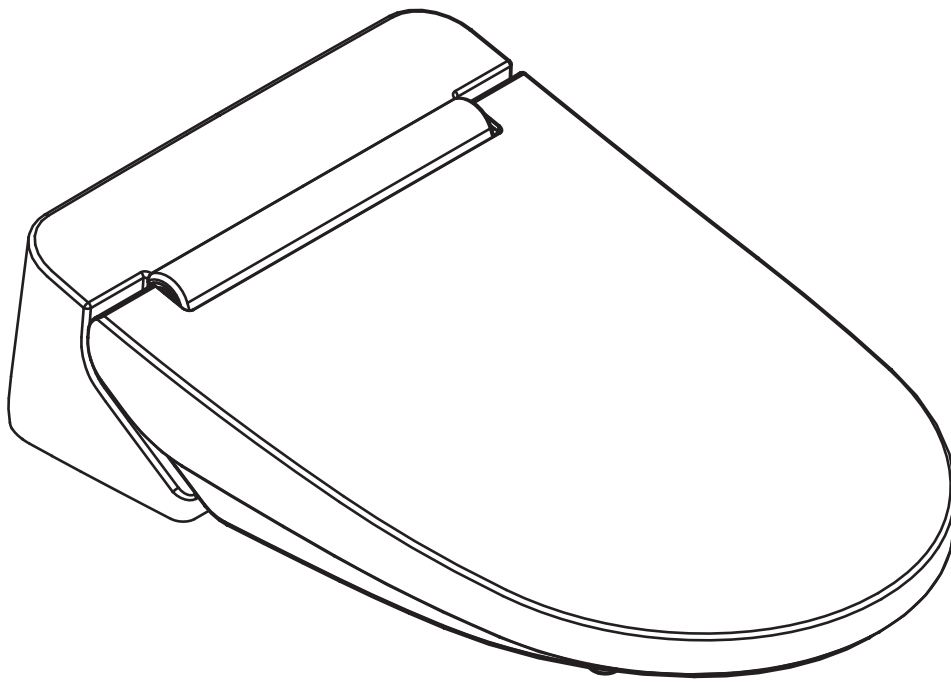

INSTALLATION & CARE GUIDE

Read all operating instructions before installation and use.

Please save this instruction manual and place in an easily accessible location.

External appearance and specifications are subject to change for improvement of product without notice.

TABLE OF CONTENTS

SAFETY PRECAUTIONS	1	CLEANING AND CARE	16
GROUNDING INSTRUCTIONS	7	TROUBLESHOOTING	18
PARTS IDENTIFICATION	9	SPECIFICATIONS	20
INSTALLATION INSTRUCTIONS	11	WARRANTY INFORMATION	21
HOW-TO-USE	14		



IMPORTANT SAFETY INSTRUCTIONS

When using electronic appliances, especially when children are present, basic safety precautions should always be followed.

READ ALL INSTRUCTIONS BEFORE USE

DANGER - As with most electronic appliances, electrical parts are live even when the appliance is powered off. To reduce risk of death by electric shock:

1. Do not use while bathing.
2. Do not place or store appliance where it can fall or be pulled into a tub or sink.
3. Do not place in or drop into water or any other liquid.
4. If an appliance falls into water, unplug it immediately. Do not reach into the water.

WARNING - To reduce risk of burns, electrocution, fire or injury to persons:

1. Close supervision is necessary when this appliance is used by, on or near children or handicapped persons.
2. Use this appliance only for its intended use as described in this manual. Do not use any attachments not recommended by the manufacturer.
3. Never operate this appliance if it has a damaged cord or plug, if it is not working properly, or if it has been dropped, damaged, or dropper into water. Contact Icera Customer Service for examination, repair and/or replacement.
4. Keep the cord away from heated surfaces. Do not wrap the cord around the appliance.
5. Never block the air openings of the appliance or place it on a soft surface, such as a bed or couch, where the air openings may be blocked. Keep the air openings free of lint, hair and other debris.
6. Never drop or insert any object into any opening or hose.
7. Do not use outdoors or operate where aerosol (spray) products are being used or where oxygen is being administered.
8. Do not use an extension cord with this appliance.
9. Use this appliance only for household use.
10. Connect this product to a properly grounded outlet only. See Grounding Instructions for further details.

CONSIGNES DE SÉCURITÉ IMPORTANTES

Lors de l'utilisation d'appareils électroniques, en particulier en présence d'enfants, des précautions de sécurité de base doivent toujours être respectées.

LISEZ TOUTES LES INSTRUCTIONS AVANT UTILISATION

DANGER - Comme avec la plupart des appareils électroniques, les pièces électriques sont sous tension même lorsque l'appareil est hors tension. Pour réduire le risque de décès par choc électrique:

1. Ne pas utiliser pendant le bain.
2. Ne placez pas et ne stockez pas l'appareil où il peut tomber ou être tiré dans une baignoire ou un évier.
3. Ne pas placer dans ou tomber dans l'eau ou tout autre liquide.
4. Si un appareil tombe dans l'eau, débranchez-le immédiatement. Ne mettez pas la main dans l'eau.

AVERTISSEMENT - Pour réduire les risques de brûlures, d'électrocution, d'incendie ou de blessures corporelles:





1. Une surveillance étroite est nécessaire lorsque cet appareil est utilisé par, sur ou à proximité d'enfants ou d'invalides.
2. N'utilisez cet appareil que pour l'usage auquel il est destiné, comme décrit dans ce manuel. N'utilisez aucun accessoire non recommandé par le fabricant.
3. N'utilisez jamais cet appareil s'il a un cordon ou une fiche endommagé, s'il ne fonctionne pas correctement, ou s'il a été échappé, endommagé ou tombé dans l'eau. Contactez le service client Icera pour un examen, une réparation et / ou un remplacement.
4. Gardez le cordon loin des surfaces chauffées. N'enroulez pas le cordon autour de l'appareil.
5. Ne bloquez jamais les ouvertures d'air de l'appareil et ne le placez pas sur une surface molle, comme un lit ou un canapé, où les ouvertures d'air peuvent être bloquées. Gardez les ouvertures d'air exemptes de peluches, cheveux et autres débris.
6. Ne laissez jamais tomber ou n'insérez aucun objet dans une ouverture ou un tuyau.
7. Ne pas utiliser à l'extérieur ni utiliser là où des produits aérosols (aérosols) sont utilisés ou où de l'oxygène est administré.
8. N'utilisez pas de rallonge avec cet appareil.
9. Utilisez cet appareil uniquement pour un usage domestique.
10. Connectez ce produit à une prise correctement mise à la terre uniquement. Voir les instructions de mise à la terre pour plus de détails.

SAFETY PRECAUTIONS







For your own safety, follow all precautions in this manual.

Caution: In order to avoid hazard due to inadvertent resetting of the thermal cutout, this appliance must not be attached to an external switching device, such as a timer, nor should it be connected to a circuit that is regularly switched on and off by utility.



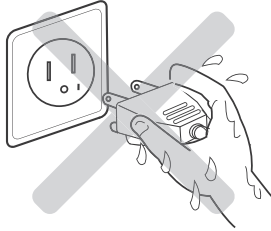

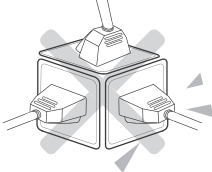





The following symbols & terms are used in this manual to indicate hazardous scenarios with varying degrees of severity:

 DANGER	Indicates an imminently hazardous situation which, if not avoided, may result in death or serious injury.
 CAUTION	Indicates a dangerous situation that may result in injury or property damage.
 PROHIBITED	Indicates a prohibited use of the product.
 OBSERVE STRICTLY	Indicates a required step in the use of the product.

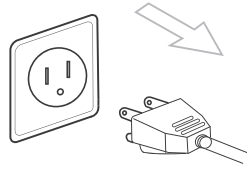
 **DANGER**

<div style="display: flex; align-items: center; justify-content: center;">  <div style="background-color: #cccccc; padding: 5px; margin: 0 10px; text-align: center;"> DO NOT DISASSEMBLE </div>  </div> <p>Never disassemble, repair or alter. Doing so may cause a fire, electrical shock, heat or a short.</p>	<div style="display: flex; align-items: center; justify-content: center;">  <div style="background-color: #cccccc; padding: 5px; margin: 0 10px; text-align: center;"> WET HANDS PROHIBITED </div>  </div> <p>Do not plug, unplug or touch the power plug with wet hands. Doing so may cause an electrical shock.</p>
<div style="display: flex; align-items: center; justify-content: center;">  <div style="background-color: #cccccc; padding: 5px; margin: 0 10px; text-align: center;"> PROHIBITED </div>  </div> <p>Do not use any outlet or wiring equipment beyond its specified rating. Plugging too many plugs into the same outlet, for example by using outlet splitters or adapters, can cause a fire due to overheating.</p>	<div style="display: flex; align-items: center; justify-content: center;">  <div style="background-color: #cccccc; padding: 5px; margin: 0 10px; text-align: center;"> OPEN FLAME PROHIBITED </div>  </div> <p>Keep cigarettes and other open flames away from this product. Failure to do so may cause a fire.</p>

SAFETY PRECAUTIONS

 DANGER	
<div style="display: flex; align-items: center;"> <div style="border: 1px solid black; border-radius: 10px; padding: 5px; margin-right: 10px;">  <p>DO NOT SPRAY WATER</p> </div>  </div> <p>Do not get any water or cleaning products on the main unit or power plug. Doing so may cause a fire, electrical shock, heat or a short. Doing so can cause the product to crack resulting in injury or water damage.</p>	<div style="display: flex; align-items: center;"> <div style="border: 1px solid black; border-radius: 10px; padding: 5px; margin-right: 10px;">  <p>OBSERVE STRICTLY</p> </div>  </div> <p>Always unplug the product from the outlet before cleaning or maintenance. Failure to do could cause electrical shock. This does not apply when using the Nozzle Clean function.</p>
<div style="display: flex; align-items: center;"> <div style="border: 1px solid black; border-radius: 10px; padding: 5px; margin-right: 10px;">  <p>PROHIBITED</p> </div> </div> <p>Do not do anything that could damage the power cord or power plug. Do not strike, yank, twist, bend, damage, heat or otherwise alter the power/electrical cords. Do not place anything heavy, bind or pinch the power/electrical cords. Using a damaged electrical cord may result in a fire, electrical shock, heat or short.</p>	<div style="display: flex; align-items: center;"> <div style="border: 1px solid black; border-radius: 10px; padding: 5px; margin-right: 10px;">  <p>OBSERVE STRICTLY</p> </div>  </div> <p>When cleaning or maintaining plastic components or the supply hose, use mild dish soap diluted with tap water and a soft cloth.</p> <p>Do not use any of the following:</p> <p>Toilet cleaner, household cleaner, benzene, paint thinner, powdered cleanser or nylon scrubbing pads.</p> <p>These items could damage or crack the plastic and cause injury or malfunction.</p> <p>These items could damage the water supply hose and cause a water leak.</p>
<div style="display: flex; align-items: center;"> <div style="border: 1px solid black; border-radius: 10px; padding: 5px; margin-right: 10px;">  </div> </div> <p>Do not use a loose or faulty electrical outlet. Doing so could cause a fire or short.</p> <p>Do not use any power supply other than the one specified (USA: AC 120V, 60Hz). Doing so could cause a fire or excessive heat.</p> <p>Do not touch the power plug in the event of a thunderstorm. Doing so could cause an electrical shock.</p>	<p>Do not use any of the following:</p> <p>Toilet cleaner, household cleaner, benzene, paint thinner, powdered cleanser or nylon scrubbing pads.</p> <p>These items could damage or crack the plastic and cause injury or malfunction.</p> <p>These items could damage the water supply hose and cause a water leak.</p>
<div style="display: flex; align-items: center;"> <div style="border: 1px solid black; border-radius: 10px; padding: 5px; margin-right: 10px;">  <p>PROHIBITED</p> </div> </div> <p>Only use tap water or potable well water (underground water). Do not use seawater. Do not connect to industrial or gray water. Doing so may cause irritation to the skin and/or product malfunction.</p>	<div style="display: flex; align-items: center;"> <div style="border: 1px solid black; border-radius: 10px; padding: 5px; margin-right: 10px;">  <p>OBSERVE STRICTLY</p> </div> </div> <p>Make sure that a properly grounded (3 prong) outlet has been installed. Failure to install a grounded outlet could cause electrical shock in the event of a malfunction or short circuit. See Grounding Instructions on page 7.</p>

SAFETY PRECAUTIONS



DANGER

BEWARE OF LOW-GRADE BURNS. Improper use of a heated seat could cause a low-grade burn. When sitting on the toilet seat for long periods of time, switch the toilet seat temperature to OFF.

Always connect the product to the cold water supply. Connecting to hot water supply may result in burns or equipment damage.

When any of the following persons use a heated seat or warm air dryer, someone should switch the seat temperature to OFF and the air drying temperature to LOW:



- Young children, elderly persons or other users unable to set the temperature appropriately themselves.
- The ill, physically disabled or other persons who do not have freedom of movement.
- Persons using any medications that may cause drowsiness.
- Those who have been drinking heavily, are otherwise intoxicated and/or are severely fatigued and anyone else liable to fall asleep during use.

SAFETY PRECAUTIONS



CAUTION

DO NOT USE THIS PRODUCT OTHER THAN FOR THE PURPOSES LISTED IN THIS MANUAL.



PROHIBITED



Do not step on or stand on the toilet seat, lid or main unit. Do not apply strong force or mechanical shock. Do not place heavy objects on the toilet seat, lid or main unit. Doing so may cause injury or product damage.



PROHIBITED



Do not put anything else into the toilet paper except for toilet paper. Doing so may cause product damage from a resulting blockage.



OBSERVE STRICTLY

Do not place hands, fingers or any other object into the warm air outlet. Do not drape clothes or linens or otherwise block the warm air outlet. Doing so could cause burns, electrical shock or product malfunction.



OBSERVE STRICTLY

If the product will not be in use over an extended period of time, unplug the main power cord. Leaving the power connected might cause a fire or overheating.



Do not use the product if a malfunction occurs. In the following cases, unplug the plug from the outlet and close the water supply valve. Continued use after malfunction could cause a fire, electrical shock, heat, short, injury or water damage.

Possible malfunctions:

- Water is leaking from a pipe or from the main unit.
- The product is making a strange noise or emits a strange odor.
- The product emits smoke.
- The product is abnormally hot.

Do not lift this product by the toilet seat or lid.

Do not raise the toilet seat or lid while objects are resting on top of the toilet. Doing so could cause the main unit to come loose and fall resulting in injury.

Do not fold or crush the water supply hose. Doing so could cause water leaks.

To prevent a sudden water leak, do not remove the water filter drain valve when the water supply valve is open. Doing so will cause to spurt out. Refer to page 16 for instruction on cleaning the water filter.

Do not use the product if the main unit is unstable. Doing so could cause the main unit to come loose and fall resulting in injury.

GROUNDING INSTRUCTIONS

This product should be grounded. In the event of an electrical short circuit, grounding reduces the risk of electric shock by providing an escape wire for the electrical current. The plug must be plugged into an outlet that is properly installed and grounded.

⚠ DANGER Improper use of the grounding plug can result in electric shock.

Check with a qualified electrician or serviceman if the grounding instructions are not completely understood, or if in doubt as to whether the product is properly grounded.

This product is factory-equipped with a specific electric cord and plug to permit connection to the proper electric circuit. Make sure that the product is connected to an outlet having the same configuration as the plug.

This product is for use on a nominal 120V circuit and a GFCI (ground fault circuit interrupter) receptacle is required for use with this product, as shown in the figure below. Do not use this product with an ungrounded outlet.

Do not use an extension cord with this product. Do not use an adapter with this product. Do not modify the plug provided - if it will not fit the outlet, have the proper outlet installed by a qualified electrician. If the product must be reconnected for use on a different type of electric circuit, the reconnection should be made by qualified service personnel.

If repair or replacement of the cord or plug is necessary, do not plug into an outlet. Contact Icera's Customer Service department to discuss possible repair or replacement.

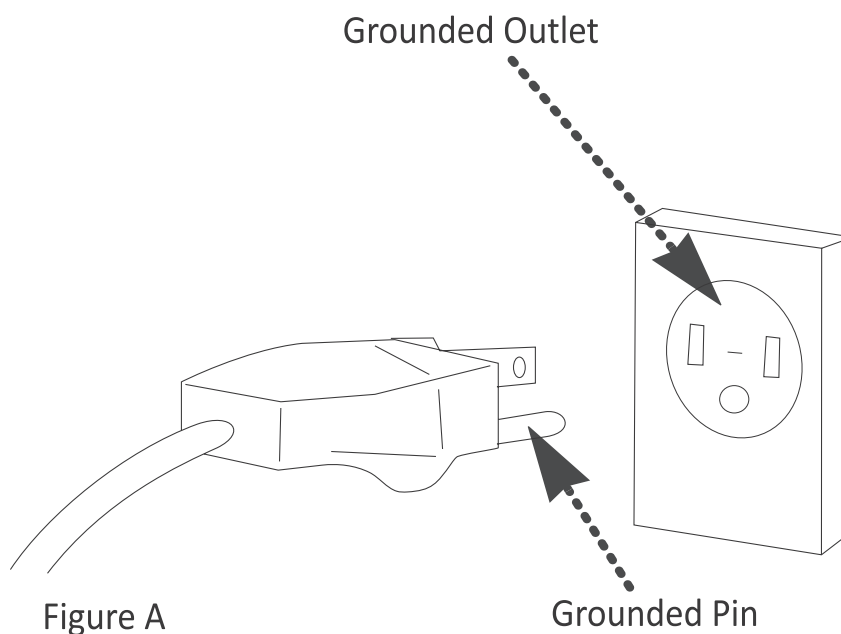

INSTRUCTIONS DE MISE À LA TERRE

Ce produit doit être mis à la terre. En cas de court-circuit électrique, la mise à la terre réduit le risque de choc électrique en fournissant un fil d'échappement pour le courant électrique. La fiche doit être branchée dans une prise correctement installée et mise à la terre.

⚠ DANGER Une mauvaise utilisation de la fiche de mise à la terre peut entraîner un choc électrique.

Vérifiez auprès d'un électricien ou d'un réparateur qualifié si les instructions de mise à la terre ne sont pas complètement comprises ou en cas de doute quant à la mise à la terre du produit.

Ce produit est équipé d'un cordon électrique et d'une fiche spécifiques pour permettre la connexion au circuit électrique approprié. Assurez-vous que le produit est connecté à une prise ayant la même configuration que la fiche.

Ce produit est destiné à être utilisé sur un circuit nominal de 120 V et une prise GFCI (disjoncteur de fuite à la terre) est requise pour être utilisée avec ce produit, comme illustré dans la figure ci-dessous. N'assurez pas ce produit avec une prise non mise à la terre.

N'utilisez pas de rallonge avec ce produit. N'utilisez pas d'adaptateur avec ce produit. Ne modifiez pas la fiche fournie - si elle ne rentre pas dans la prise, faites installer la prise appropriée par un électricien qualifié. Si le produit doit être reconnecté pour être utilisé sur un autre type de circuit électrique, la reconnexion doit être effectuée par un technicien qualifié.

Si la réparation ou le remplacement du cordon ou plus est nécessaire, ne branchez pas sur une prise. Contactez le service client d'Icera pour discuter d'une éventuelle réparation ou remplacement.

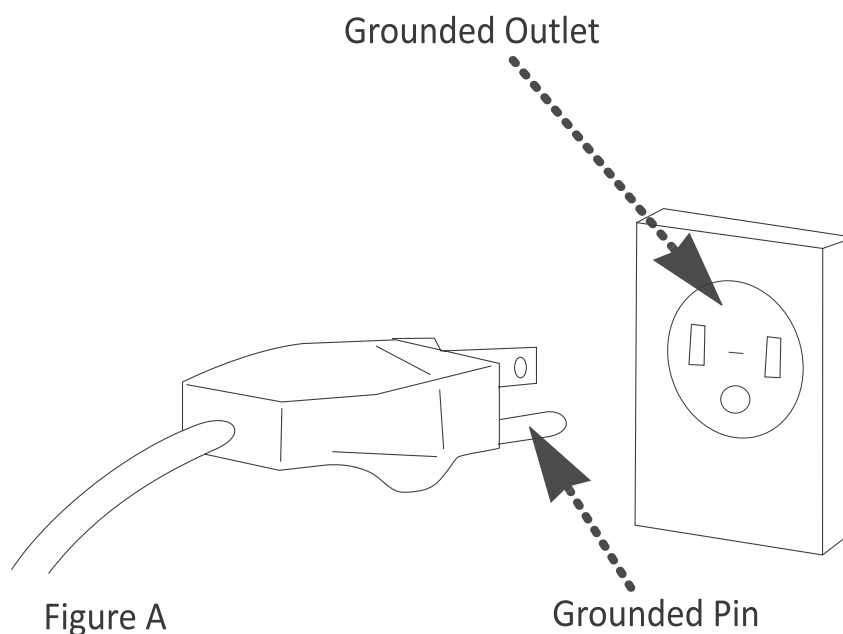

PARTS IDENTIFICATION

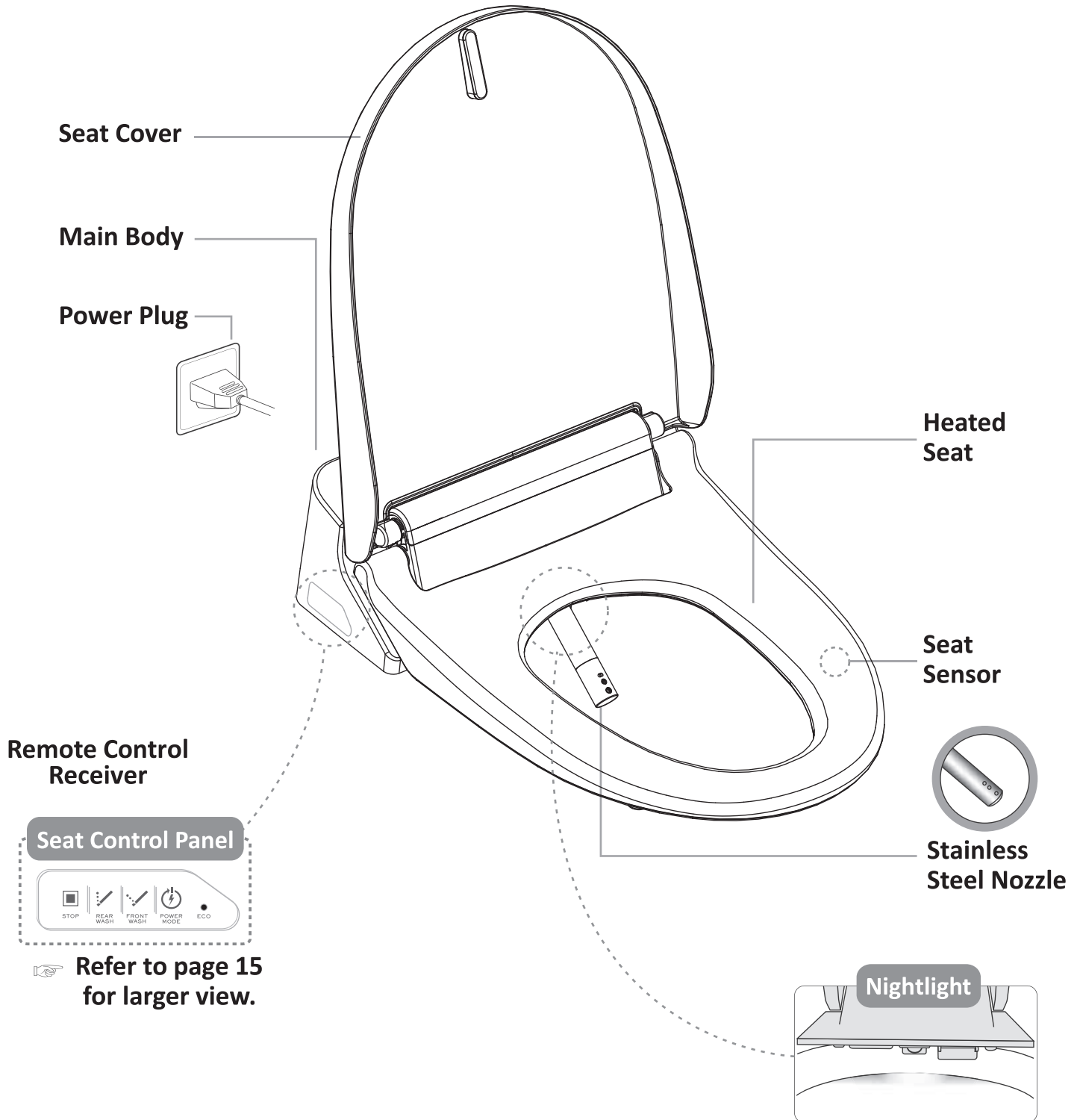

PARTS IDENTIFICATION

MOUNTING HARDWARE (included)

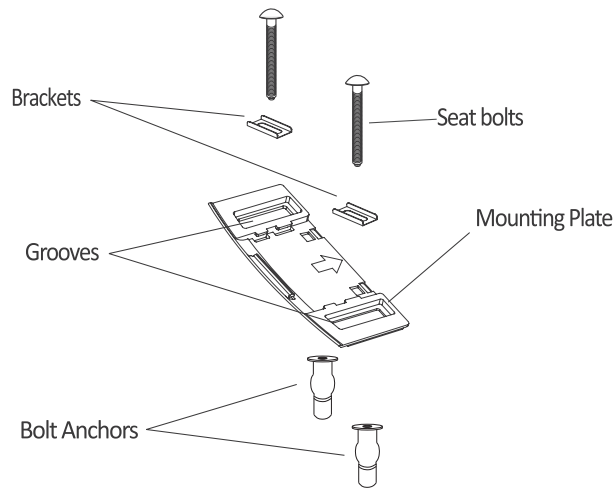

VALVES/HOSES (included)

7/8" x 7/8" x 1/2"
T-Valve

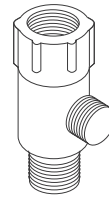

1/2" x 1/2" x 19"
Transfer Hose

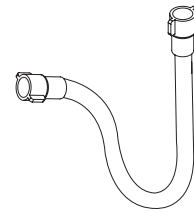

LED BACKLIT REMOTE CONTROL (included, with 3 AAA batteries)

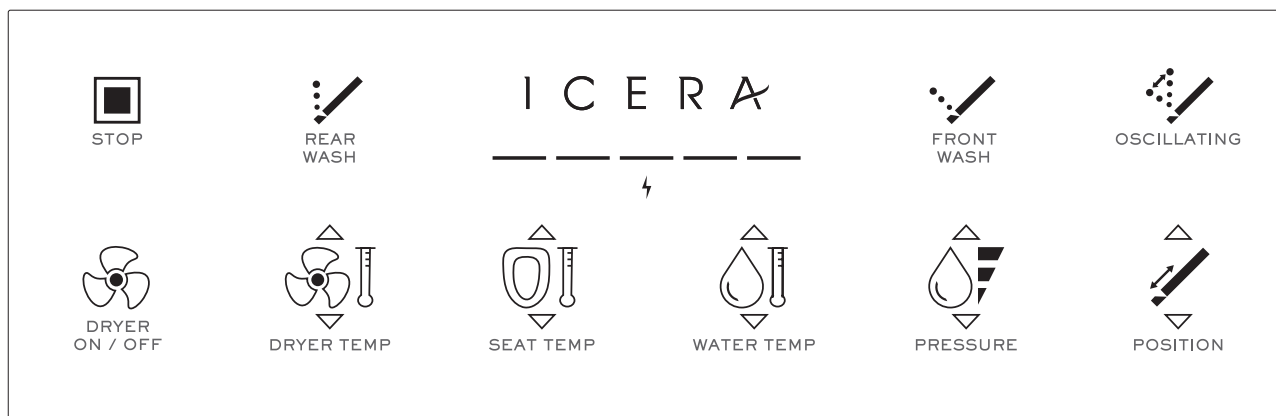

REQUIRED BUT NOT INCLUDED

- Water supply line
- Water supply valve (angle-stop)
- Philips head screwdriver
- GFCI outlet

INSTALLATION INSTRUCTIONS

CAUTION BEFORE INSTALLATION!



- Check whether the size and shape of the toilet seat are suitable for installation.
- Make sure all accessory parts are present.
- Do not connect the power until installation is complete.
- Ground connection should be done by an authorized service person only.

INSTALLING THE MAIN UNIT

1 Remove existing toilet seat

- Remove the existing toilet seat and lid by unfastening the seat bolts on the underside of the bowl.

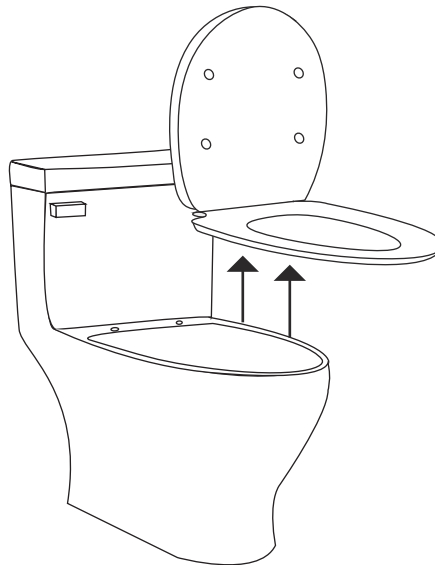

2 Turn off the water supply and completely drain toilet tank.

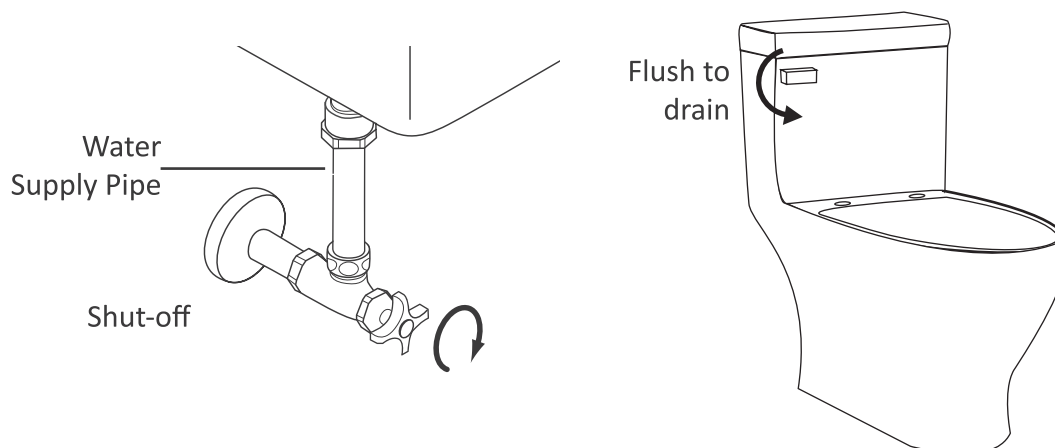

INSTALLATION INSTRUCTIONS

3 Detach water supply pipe from toilet tank and install T-valve

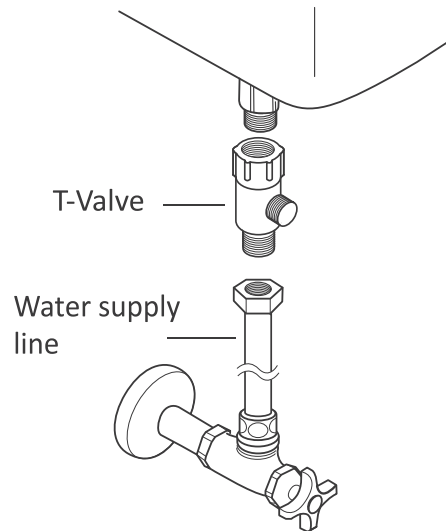

4 Align the grooves of the mounting plate with the toilet seat bolt holes

- Bolt holes must be 5.5" (140 mm) apart

5 Place the brackets on the mounting plate

6 Insert the rubber bolt anchors into the seat bolt holes on the toilet bowl, then fasten the mounting plate to the bowl with the seat bolts provided

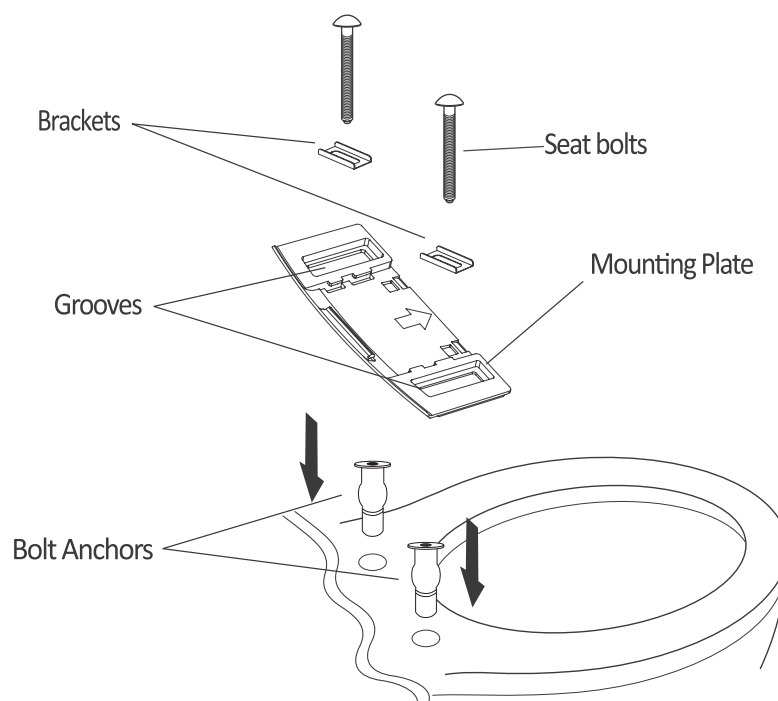

INSTALLATION INSTRUCTIONS

- 7** Use the grooves on the underside of the unit to slide the unit onto the mounting plate

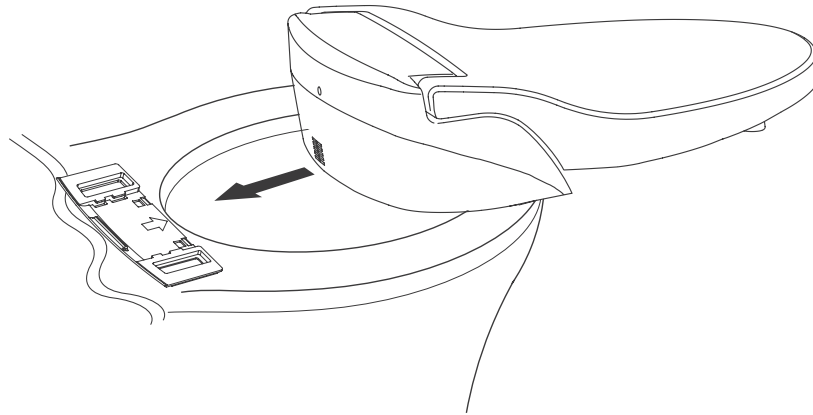

- 8** Connect the transfer hose to the water inlet on the bidet seat and the T-valve. Turn the water supply valve counterclockwise to allow water flow.

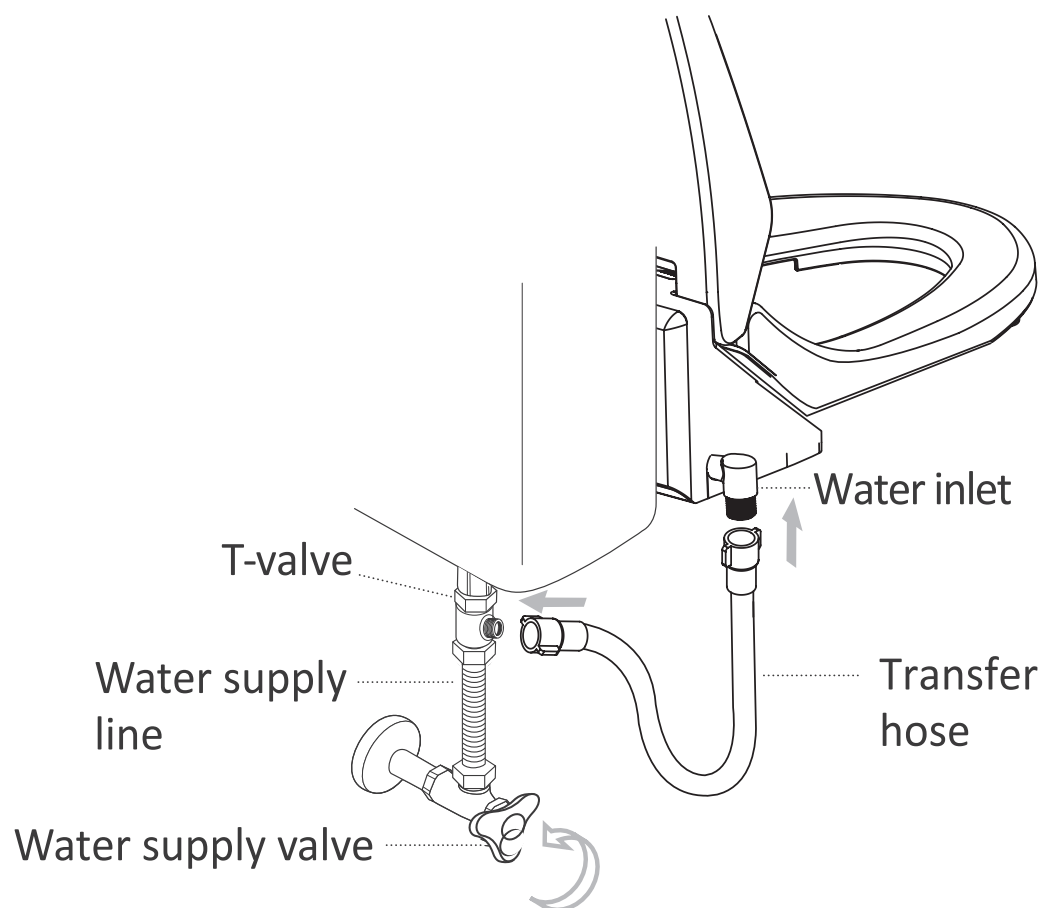

iWASH FEATURES & REMOTE GUIDE

FRONT VIEW

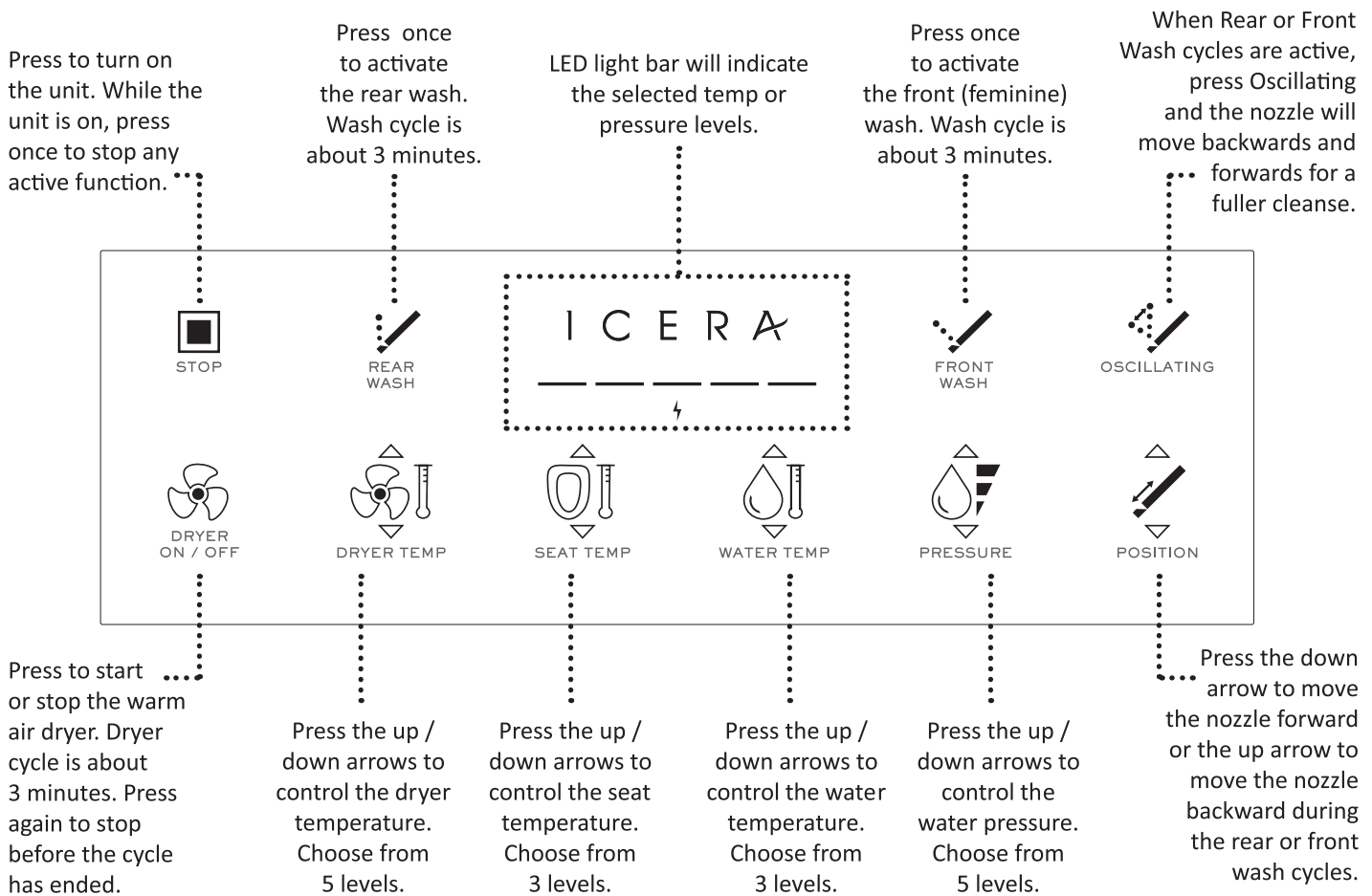

TOP VIEW

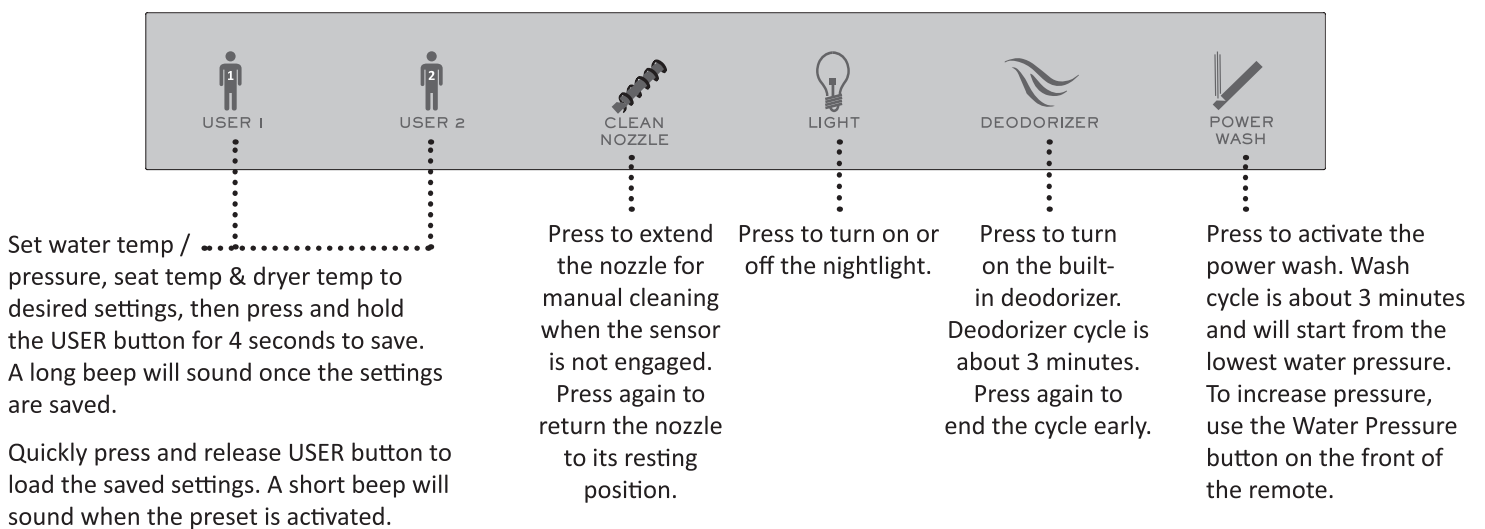

iWASH SEAT PANEL GUIDE

If your iWash remote is not operational (e.g., lost, dead batteries, damaged or otherwise not working), the basic wash functions of your bidet seat can be controlled from the seat panel located on the left-side of the seat (when facing the unit from the front). These controls will only activate or stop the spray functions. Temperature, pressure and nozzle position settings cannot be changed using the seat panel controls. All temperature / pressure levels and nozzle position will default to the last used settings engaged by the remote control. The Power Wash function cannot be activated using the seat panel controls.

Your seat's power modes are controlled using the seat panel.

Contact Icera Customer Service at 855-444-2372 or service@icerausa.com, if a replacement remote is needed.

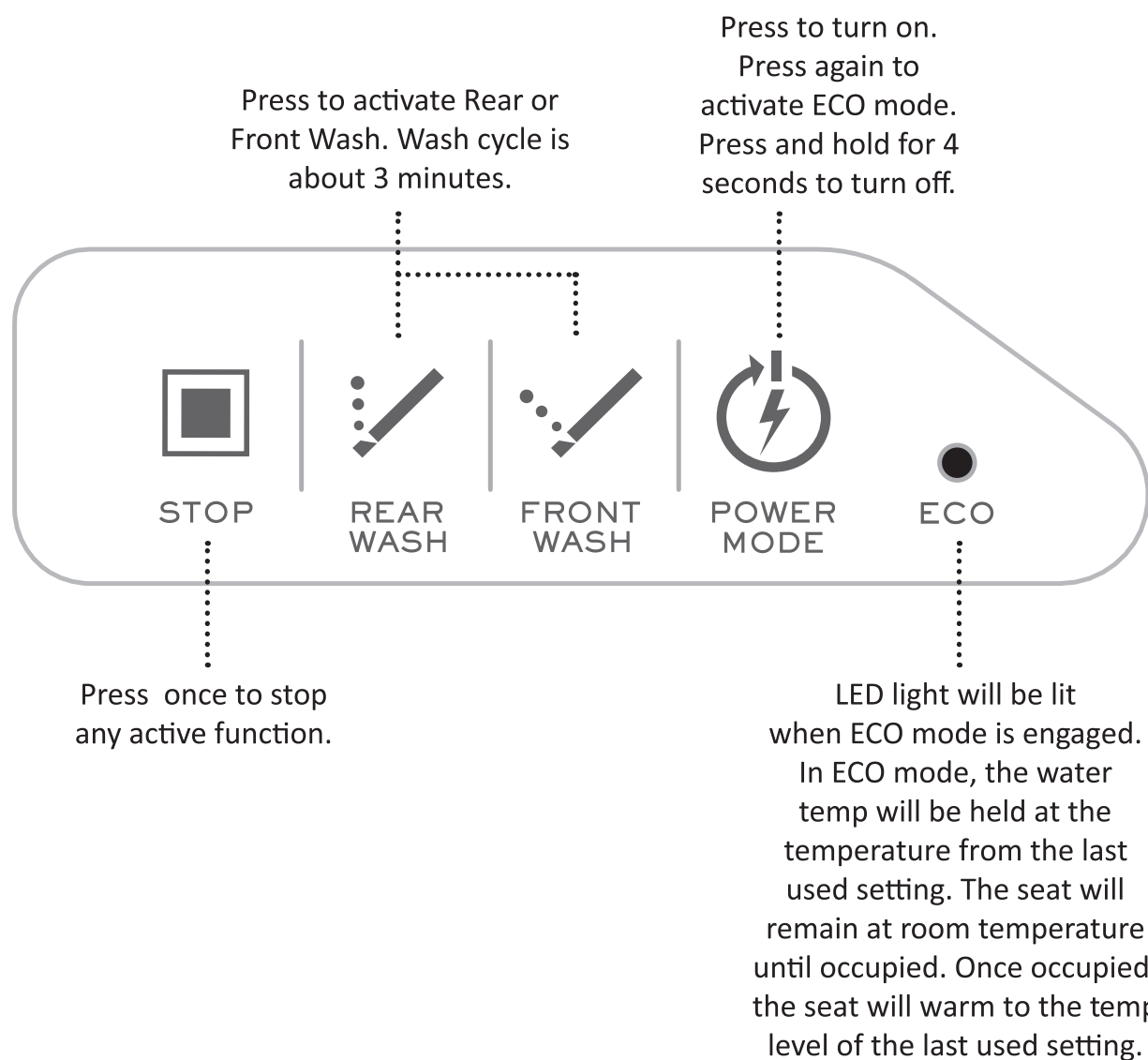

CLEANING YOUR iWASH

For your safety, make sure the unit is powered **OFF**
AND unplugged before cleaning.

1 CLEANING THE WATER FILTER

- Turn off the water supply by turning the water supply valve clockwise.
- Detach the transfer hose from toilet seat to expose the water filter.
- Clean the filter gently with a soft brush.
- Re-insert the filter and reattach the transfer hose.
- Turn the water supply back on by turning the water supply valve counterclockwise.

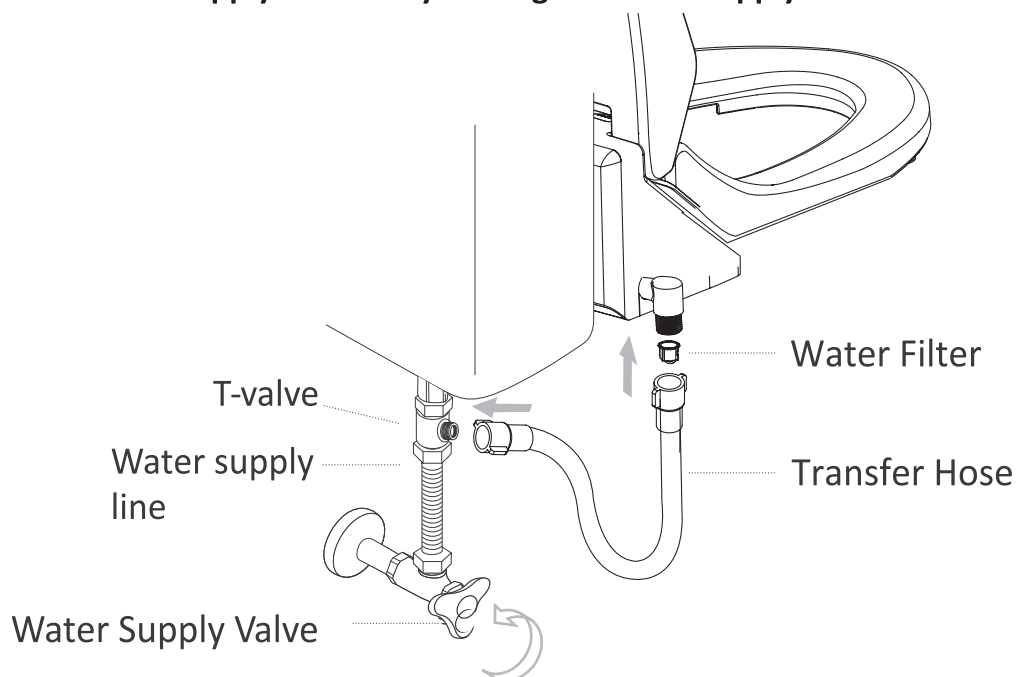

2 CLEANING THE BIDET NOZZLE

- Press the **CLEAN NOZZLE** button on the top of the remote control to extend the nozzle.
- Clean the nozzle gently with a soft brush.
- Do not pull the nozzle out or exert force while cleaning. This may cause product damage.
- Press the **CLEAN NOZZLE** button on the top of the remote control again to return the nozzle to its resting position.

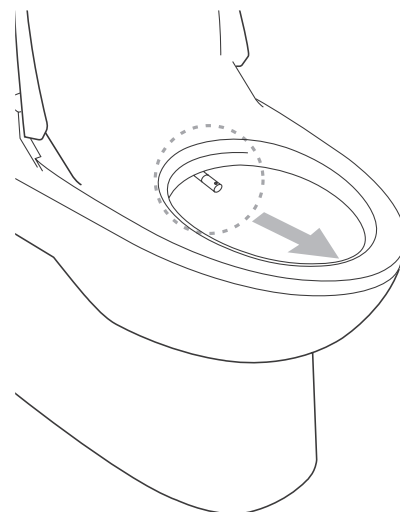

CLEANING YOUR iWASH

For your safety, make sure the unit is powered OFF
AND unplugged before cleaning.

3 EXTERNAL CLEANING

- The external casing of the seat is made of a plastic which may be damaged by coarse brushes / pads, harsh chemicals, etc. Test any household cleaner on a inconspicuous area before using. Do not use toluene, mineral oil, heptane and nitric, chromic or sulfuric acids to clean this product.
- Disconnect the power plug before cleaning. Be careful not to splash water onto the plug or outlet.
- Clean the unit with a soft, wet cloth - wring out excess water from the cloth before cleaning.
- Do not spray water onto the unit.

WARNING: Touching the power plug and / or outlet with wet hands may result in electric shock.

TROUBLESHOOTING GUIDE

ISSUE	POSSIBLE CAUSES	SOLUTION
No power	<ul style="list-style-type: none"> • Unit is not plugged in • Unit is not turned on. • Circuit breaker is switched off 	<ul style="list-style-type: none"> • Check that the power plug is securely plugged into the outlet. • Power on the unit by pressing the POWER MODE button on the seat control panel. • Make sure the circuit breaker for the outlet is switched on.
Weak water pressure	<ul style="list-style-type: none"> • Water pressure is set to a low level. • Water filter is clogged. 	<ul style="list-style-type: none"> • Adjust the water pressure level to a higher setting using the remote control. • Clean the water filter. See page 16 for instructions.
Water is cold	<ul style="list-style-type: none"> • Water temperature is set to a low level. 	<ul style="list-style-type: none"> • Adjust the water temperature level to a higher setting using the remote control.
Water spray stops during use.	<ul style="list-style-type: none"> • Wash cycle has ended. • Seat sensor is not activated. 	<ul style="list-style-type: none"> • Wash cycles automatically stop after approximately 3 minutes. Press the desired wash cycle button again to restart another cycle. • Seat sensor must be activated by touch for wash cycles to operate. Check page 9 for sensor location on the seat.

TROUBLESHOOTING GUIDE

ISSUE	POSSIBLE CAUSES	SOLUTION
Seat is not warm.	<ul style="list-style-type: none"> • Seat temperature is set to a low level. • Unit is in ECO (energy-saving) mode. • The seat has been occupied for more than 1 hour. 	<ul style="list-style-type: none"> • Adjust the seat temperature level to a higher setting using the remote control. • When ECO mode is active, the seat temperature is held at 86° F (30° C). Once the seat is occupied, the seat will begin to warm to the last used setting. • To protect against low-grade burns, the heated seat will turn off once occupied for 1 hour.
Wash or deodorizer cycle(s) function when seat is unoccupied	<ul style="list-style-type: none"> • Seat is wet. • Object is covering the seat sensor. 	<ul style="list-style-type: none"> • Make sure the seat is dry when not in use. • Make sure no objects (e.g., towels, sponges) are placed on the seat sensor.
ECO mode is not working	<ul style="list-style-type: none"> • Seat has been unplugged since the last time ECO mode was turned on. 	<ul style="list-style-type: none"> • Restarting the seat will disengage the ECO mode. Press POWER MODE on the seat panel while unoccupied to turn ECO mode on again.
Remote control is not working	<ul style="list-style-type: none"> • Batteries are dead. • Batteries are inserted incorrectly. • Remote control receiver is blocked and / or dirty. • Seat is unoccupied 	<ul style="list-style-type: none"> • Replace batteries and test function. • Make sure batteries are inserted correctly and test function. • Remove any objects blocking the remote control receivers and make sure they free of dust and / or water stains. • Most functions will not work if the seat is unoccupied. Make sure the seat sensor is being engaged. See page 9 for sensor location.

PRODUCT SPECIFICATIONS

Item		Specification
Rated Voltage		AC 120V, 50/60Hz
Rated Power Consumption		1300W
Water Supply System		Direct connection with tap water
Waterproof Rating		IPX4
Power Cord Length		1.5M (5ft)
Bidet Spray	Water Heating	Ceramic Heater
	Rear Wash	Maximum 800cc
	Front Wash	Maximum 800cc
	Power Wash	Maximum 800cc
	Water Temperature	86°F (30°C), 97°F (36°C), 100°F (38°C), 104°F (40°C)
	Heater Capacity	1200W
	Safety Device	Thermal cutoff, thermo switch, water level sensor
Heated Seat	Seat Temperature	Ambient, 97°F (36°C), 100°F (38°C), 104°F (40°C)
	Heater Capacity	Maximum 55W
	Safety Device	Thermal cutoff, temperature sensor
Warm Air Dryer	Dryer Temperature	Room temperature - maximum 113°F (45°C)
	Heater Capacity	Maximum 250W
	Safety Device	Thermal cutoff, Bimetal
Deodorization		Automatic deodorizer
Lighting		LED Light
Inlet Water Temperature		41°F - 95°F (5°C - 35°C)
Ambient Temperature		41°F - 95°F (5°C - 35°C)
Country of Origin		Made in Korea
Dimension		20.8" x 15.3" x 5.1" (Elongated)
Net Weight (Gross Weight)		8.3lb (13.2lb)

WARRANTY INFORMATION

3-YEAR LIMITED WARRANTY

For electronic bidet seats and integrated bidet toilet seats, Icera provides a warranty against defects in material and workmanship limited to three (3) years from the date of purchase. Scratching, staining, and other effects from chemical use, water, and atmospheric conditions are not considered manufacturing defects but are considered normal wear and tear. Use of the bidet seat with non-confirming electricity supply / water supply pressure, outside of the specified supply parameters, will void the warranty.

IMPORTANT!

Icera is not responsible for removal or installation costs.

The above warranty is extended only to the original purchaser of the product(s). This warranty is non-transferable. Proof of purchase is required for all warranty claims. This warranty is voided and does not apply where items have been improperly stored, damaged or improperly installed.

Icera reserves the right to inspect claimed defective products. Icera will, at its election, repair, replace or make appropriate adjustment where Icera inspection discloses any such defects occurring in normal usage within the warranty period after purchase. Comparable products will be offered as replacements for products not then available. Some replacement parts may vary from those originally supplied and are subject to availability.

Warranties are not applicable to products sold by unauthorized resellers. The consumer accepts responsibility to research the integrity and reputation of the reseller to ensure they are authorized to sell and provide appropriate pre purchase and post purchase service. Internet resellers should be particularly scrutinized as they are very difficult to evaluate and often provide very limited or no customer service.

This warranty applies to unmodified products when properly installed and maintained per factory instructions for their normal and intended application. Icera highly recommends installation by a licensed professional plumbing contractor. To obtain service or to purchase replacement parts not covered by the above warranty, contact your local Icera dealer.

Icera reserves the right to make changes in product design, manufacturing process, packaging, or availability at any time without notice.

Implied warranties including that of merchantability and fitness for a particular purpose are limited to the duration of this warranty. Icera and/or dealer expressly disclaims any liability for special, incidental or consequential damages.

Some states/provinces do not allow limitations on how long an implied warranty lasts, or the exclusion or limitation of special, incidental or consequential damages, so these limitations and exclusions may not apply to you. This warranty gives you specific legal rights. You may also have other rights which vary from state/province to state/province.

This is Icera's exclusive written warranty. This exclusive written warranty is issued in lieu of all other warranties, expressed or implied, including but not limited to the implied warranties of merchantability and fitness for a particular purpose.







ICERA USA

P. O. BOX 4238
WESTMINSTER, CA 92684

P: 855-444-2372
E: service@icerausa.com

S-11-MANUAL
v.201 - PRINTED MAR 2020

