

Parts Included	QTY
A - Vessel Sink	1
B — Mounting Screw	4

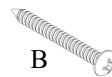

Not Drawn to Scale

### 1 Installation Steps

1. At the drain location, mark the circular cutout on the counter to facilitate the drain. The holes should be 3 1/2" diameter.

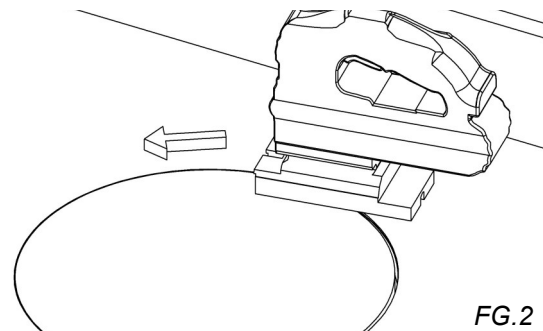

FG.2

2. Cut out the counter -The cutting tools required will depend on the surface to be cut. *FG.2* (Your sink comes with 4 mounting screws for mechanical fastening. Screws are only necessary if for some reason silicone cannot be used. In this case, you will need to drill 4 holes in the counter to accommodate these screws)

3. Apply a bead of silicone to the perimeter of the hole at the point at which the sink sits on the counter. *FG.3*

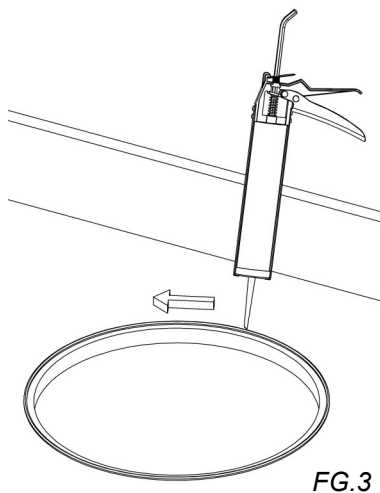

FG.3

4. Lower the sink onto the hole and ensure that it makes contact with the silicone. *FG.4*

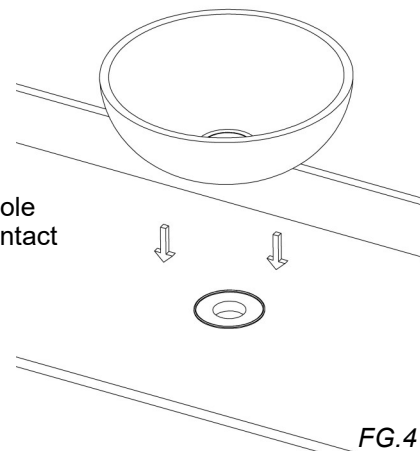

FG.4

Model #	Description	Finish	Weight (lb)	Height from Countertop	WxD (mm)	WxD (Inches)
B9311	Gabrielli Vessel Sink	Gloss White	15	6 1/4"	420 x 420	16 1/2" x 16 1/2"

**Warranty:** 5 Years

**Care & Maintenance:** Simple inexpensive household ingredients such as vim cleaner, vinegar, or water with lemon can be used to clean your cast marble basin. Surfaces may be cleaned with standard nonabrasive cleaning agents.

**Material specifications:** A natural composite of cast marble containing 70% natural aggregate dolomite rock, polyester resins and gel coat.

**Overflow:** Not Included

**Front Counter Section**

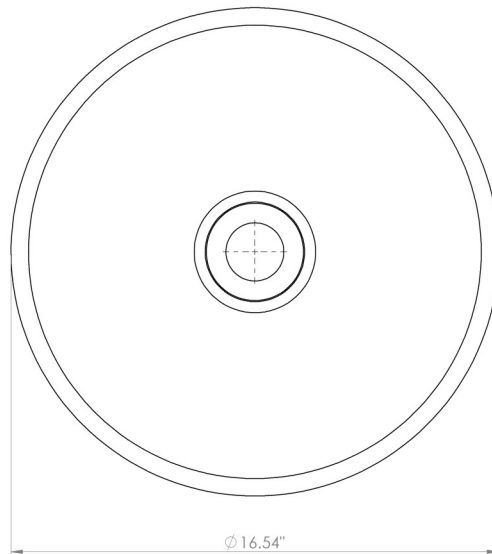
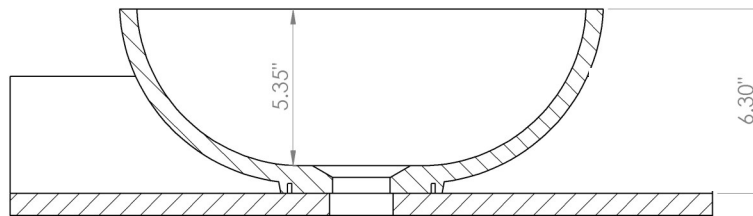

**Top**

**Checkpoint 1:**

When positioning the sink in the counter, ensure there is room for the faucet and escutcheon between the sink & the face of the backsplash.

**Checkpoint 2:**

If you need to cleanup silicone from the edge of the sink, do not use acetone, paint thinner or similar products. Putting blue tape on the counter & around the sink whilst embedding the sink into the silicone helps to keep silicone off the sink.

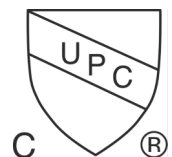

**All Dimensions are in Inches**