

DETAIL A
SCALE 1:2

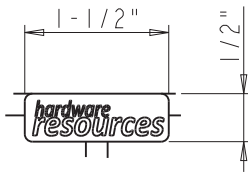

DETAIL B
SCALE 1:2

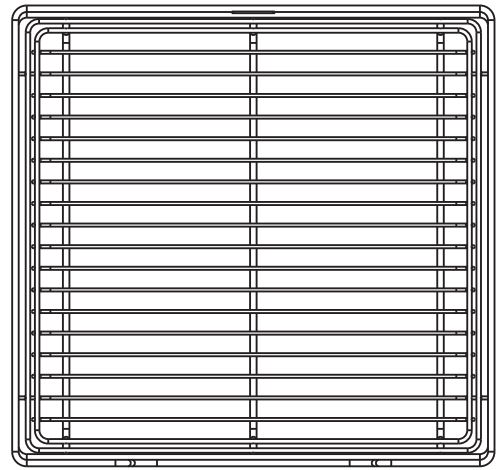
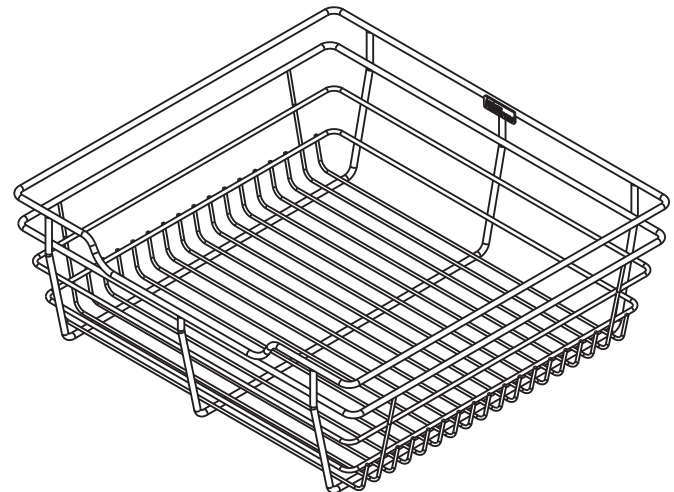

	ITEM:	POB1-16176CH		MATERIAL:	STEEL	
	FINISH:			WEIGHT:	1718.29 g	
PROPRIETARY AND CONFIDENTIAL THE INFORMATION CONTAINED IN THIS DRAWING IS THE SOLE PROPERTY OF HARDWARE RESOURCES INC. ANY REPRODUCTION IN PART OR AS A WHOLE WITHOUT THE WRITTEN PERMISSION OF HARDWARE RESOURCES INC. IS PROHIBITED.	TOLERANCE UNLESS OTHERWISE SPECIFIED: X ±0.20 XX ±0.10 XXX ±0.05 ANGULAR: ±0.5°		UNITS:	IN	DRAWN BY:	
	DO NOT SCALE DRAWING		SIZE:	A4	APPROVED BY:	
			SHEET:	1 OF 1	RELEASE LEVEL:	REVISION:
			DATE:	03-23-15		