

P6760301-1, P6760302-1, P6760303-1 - Thermostatic Shower Package without valve

Description

Thermostatic Shower package one includes:

- Shower arm - (P09281xx)
- Shower head - (P11271xx)
- 1.8 GPM ASME Compliant
- 1/2" Connection
- Valve trim - (P27251xx)
- Includes:
 - Face plate
 - Lever handles
 - Decorative sleeve for valve
- Thermostatic valve - (P2023199) - NOT INCLUDED
- Hand shower - (P04311-xx)
- Single setting hand shower
- Solid brass construction
- Wall bracket - (P04321xx)
- Solid brass construction
- Hose - (P02414xx)
- Supply elbow - (P06331xx)
- Solid brass construction



P6760301-1

Standards

- Complies with IAPMO cUPC
- ASSE 1016
- ADA Accessibility Guidelines for Buildings and Facilities - 4.27.4 Controls and Mechanisms (lever handle only)



Colors / Finishes

- P6760301-1 - Chrome
- P6760302-1 - PVD Satin Nickel
- P6760303-1 - Antique Bronze

**BREAK DOWN
Component Parts List**

NO.	Part No	Qty
01	P09284xx	1
02	P11271xx	1
03	P27251xx	1
04	P04311xx	1
05	P06331xx	1
06	P04321xx	1
07	P02414xx	1

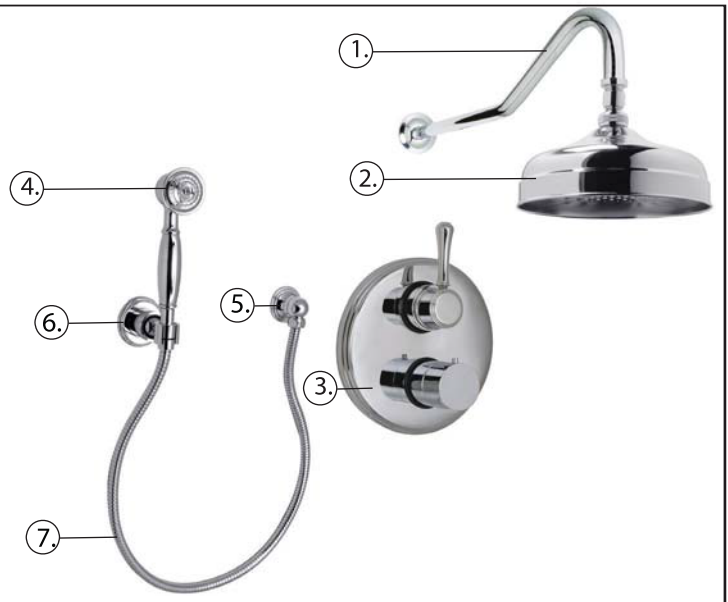

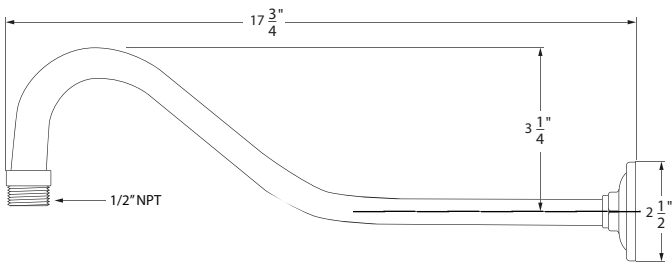

Shower arm - P09281xx

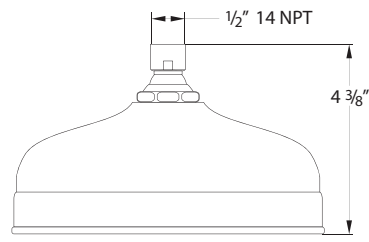

Shower Head - P11271xx

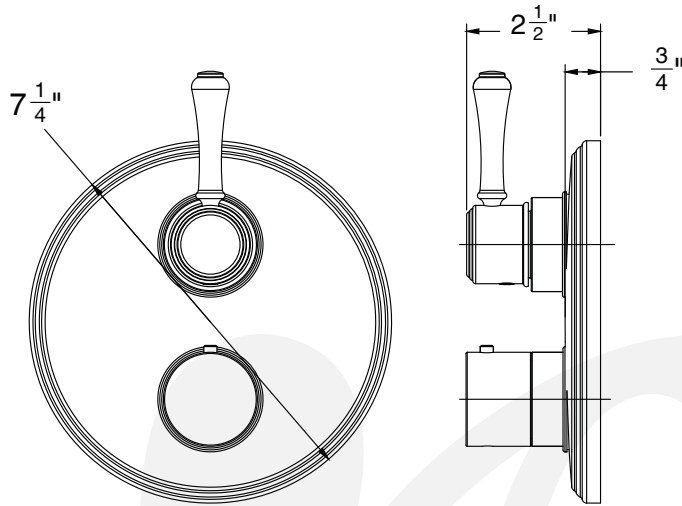
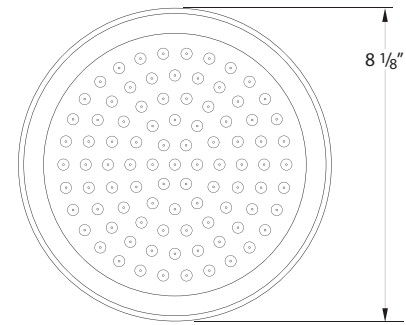

Valve Trim - P27251xx

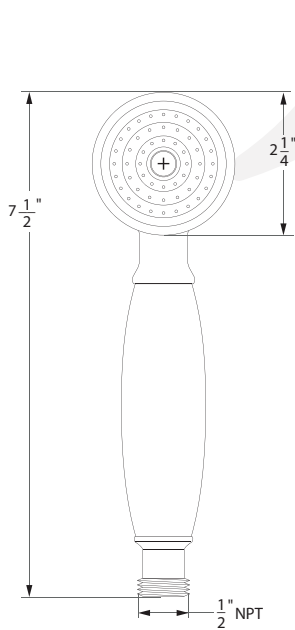

Hand Shower - P04311xx

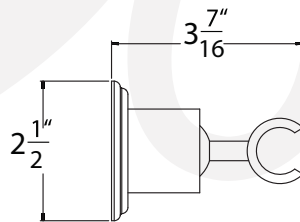

Wall Bracket - P04321xx

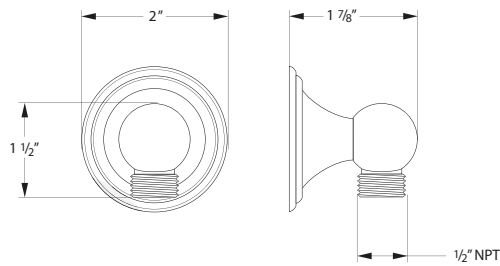

Supply Elbow - P06331xx

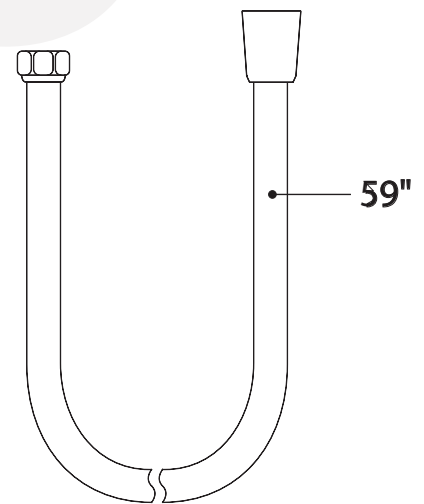

Hose - P02414xx

Item Number	Type	Date
P6760301-1, P6760302-1, P6760303-1	1/2" Thermostatic Package without valve	02/21/2018