

P6681701, P6681702, P6681749 - Thermostatic Shower Package

Description

EMORY II THERMOSTATIC SHOWER

- Single setting rain shower head
- Single setting hand shower
- Brass Hand shower wall bracket
- Brass supply elbow
- Face plate with handle assembly
- 59" PVC shower hose

This thermostatic package includes:

- Shower arm (P05281xx-2)
- Rain shower head (P34273xx)
- Thermostatic trim (PCB883xx-1)
- Thermostatic handle (PHB342xx)
- Hand shower (P21313xx)
- Wall bracket (P04321xx)
- Hose (P01413xx)
- Supply elbow (P10331xx)

• No Substitutions Allowed

• VALVE SOLD SEPARATELY:
(Use with P2023199 Valve)

P6681701



Standards

- Complies with IAPMO cUPC
- ASSE 1016
- ADA Accessibility Guidelines for Buildings and Facilities - 4.27.4 Controls and Mechanisms (lever handle only)



Colors / Finishes

- P6681701** Chrome
- P6681702** PVD Satin Nickel
- P6681749** Matte Black

BREAK DOWN
Component Parts List

NO.	Part No	Qty
1	P05281xx-2	1
2	P34273xx	1
3	PCB883xx-1	1
4	P34273xx	1
5	P10331xx	1
6	P01413xx	1
7	P04321xx	1
8	P21313xx	1

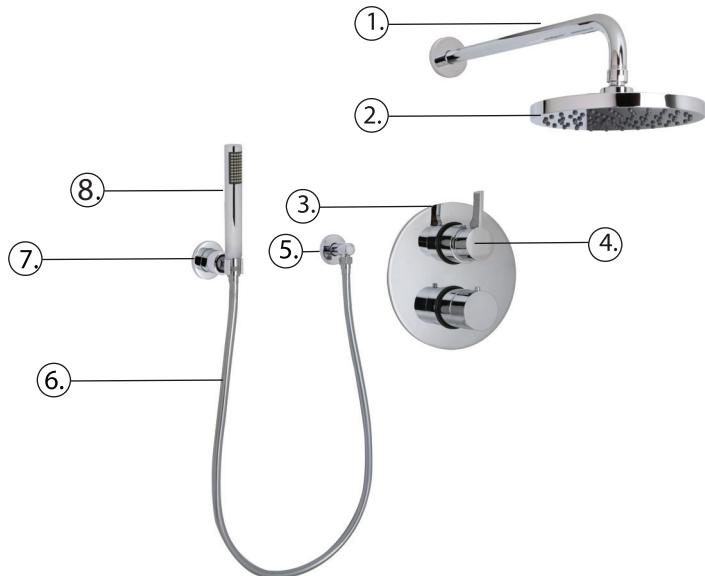

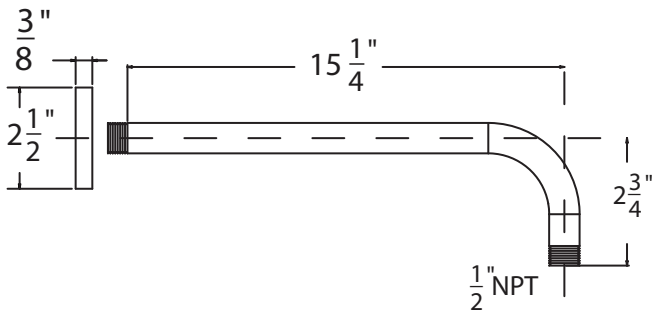

Shower arm (P05281xx-2)

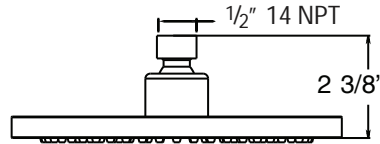

Rain shower head (P34273xx)

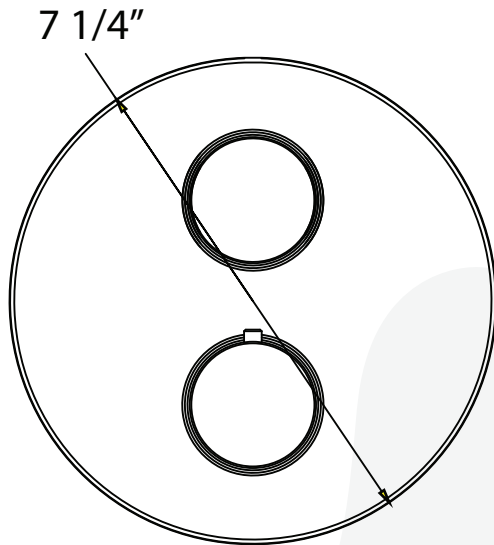
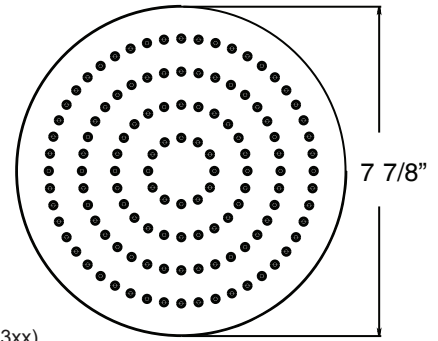

Thermostatic trim (PCB883xx-1)

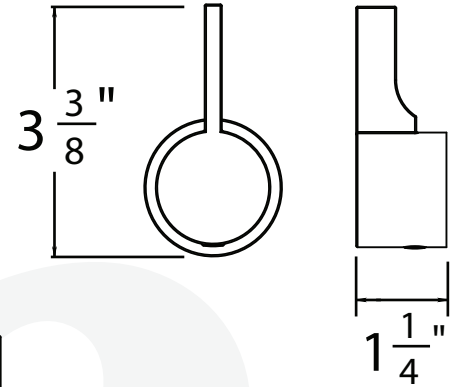
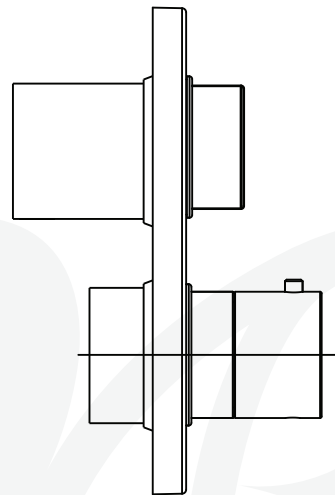

Thermostatic handle (PHB342xx)

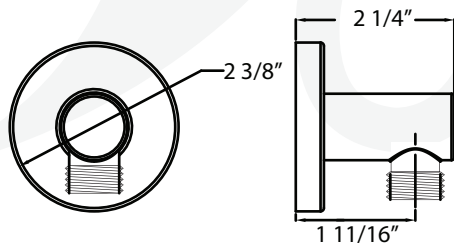

Supply elbow (P10331xx)

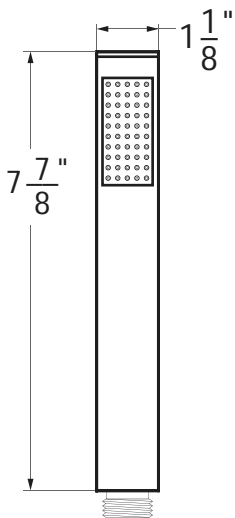

Hand shower (P21313xx)

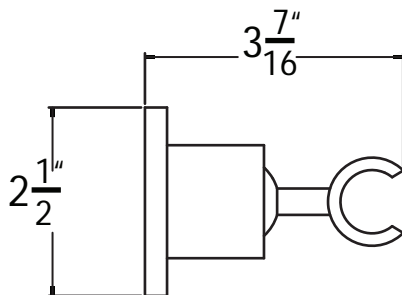

Wall bracket (P04321xx)

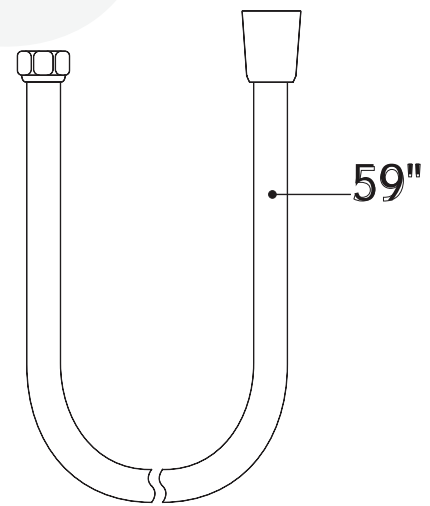

Hose (P01413xx)

Item Number	Type	Date
P6681701, P6681702, P6681749	Thermostatic Shower Package	8-27-2021