



Shower Pans Installation Instructions

Gelcoat & Solid Surface Bathware

Tools/materials you might need for proper installation

- hammer
- drill with phillips screw bit
- 1/2" notched trowel
- 1/8" drill bit
- 1/4" carbide tipped drill bit
- center punch
- spatula
- auger mixing tool for drill
- caulking gun
- 4' level
- 2' level
- nails
- (50+) 1 1/4" wood screws
- solid wood flooring adhesive
- (2) one gallon buckets per shower
- two gallons of water - for mixing bedding compound and water test around drain
- tube of 100% clear silicone caulking
- (3) 8' 2x4s
- (1) 8" long 2x4
- (1) 24" long 2x4
- self-caulking shower drain fitting

For best results, please read and follow all directions carefully.

1. Avoid exposure to weather. Product carton is not waterproof. Carton exposed to rain or snow may result in accumulated water penetrating the back laminates of the shower pan and soak the glassed in reinforcement supports causing bulges in the gelcoat surface.
2. Most handling damage is the result of impact blows to the back of the fiberglass units.
3. Never drag this fiberglass product on any surface. Always carry the pan or use a two wheel dolly. Due to the size and weight of the product, installation is easier if it is a two person operation.
4. Never drop the fiberglass shower pan from any height, not even an inch or stress cracks are likely to occur.
5. Placing objects inside the unit can cause scratches or nicks to the finished surface. Do not use the shower pan as a trash receptacle! Always place a drop cloth or cardboard on the floor when working inside the shower.
6. Never clean fiberglass gelcoat surface with metal tools of any kind, including razor blades.

PLANNING YOUR INSTALLATION

1. Review the Framing Diagrams in Figure 1. Modify existing framing if required. For new construction, build framing structure in accordance with product dimensions and notes shown in the Framing Diagrams. The two wall Framing Diagram is for the 6060 double entry shower pan only.

BRIEF OVERVIEW

Please read instructions before beginning the installation.

Note: Unit will not install properly if framing pocket is not square and of proper size. The dimensions shown in the FRAMING DIAGRAM is 1/4" larger than the size of the shower. This product is manufactured to tight specifications. The 1/4" over sizing is for maneuvering and installation ease. If 1/4" over is not reasonable, sizing closer to the product actual dimensions is allowable.

When trial fitting the shower, use a level to confirm the pan is level and plumb. If any gaps are present between the shower and framing, use furring strips to fill the gaps. A quality installation of the shower pan is necessary to assure fabrication of enclosure walls will result in a square and plumb finished shower (Note: wall enclosure is provided by others).

2. The shower pan will be installed, leveled, and fastened to the framing. It is essential the framing pocket be square and plumb for the shower pan to install properly. The floor also must have no voids or out of level conditions. If these are present, they must be corrected before installation. Floor leveling compound can be purchased at a local home improvement store.
3. Develop a plan for structure and finished wall materials to construct the shower wall enclosure before beginning the installation of the shower pan.
4. If bolt on accessories such as grab bars or a seat may be installed, plan to provide solid mounting supports for these items. Wood secured between the framing studs will be required to provide a mounting surface to install grab bars and a seat.
5. Plan for the location of the shower water control valve. Plan for routing the water supply lines to the control valve installation location.



Shower Pans Installation Instructions

Gelcoat & Solid Surface Bathware

6. In the installation location, the drain opening in the floor should have a 6" core for the drain pipe, and a 10" x 10" x 1/2" deep recess in the sub floor. (The drain core must be blocked when filled with Thin-Set). The 10" x 10" x 1/2" deep recess is required to assure proper drainage.

See Detail of Drain Core Area

7. Check the outside of the package for visible shipping damage. If damage is noted, contact your supplier before proceeding with the installation.

8. Locate accessories if any were ordered. They will be packaged in the pan box. Remove those and store them in a safe location for easy retrieval.

9. The shower curtain rod has not been pre-cut prior to shipping. Once the product is installed, measure the desired width and make the cut using an abrasive cutting blade designed for metal.

10. Semi-permanent thresholds - see the last page of installation instructions for details for trimming to fit the product.

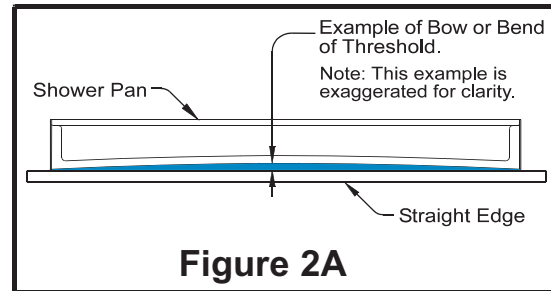

Figure 2A

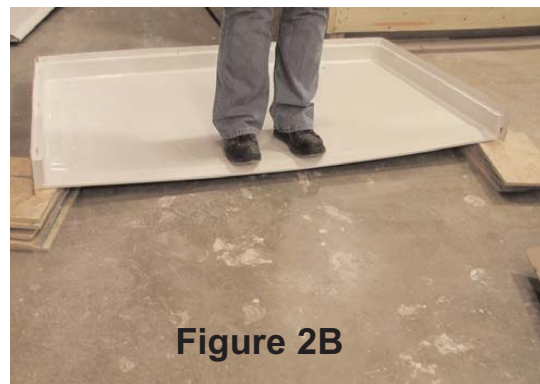

Figure 2B

INSTALLATION INSTRUCTIONS

1. Prepare the installation area by sweeping the area completely clean.

2. Framing pocket must be sized according to the information provided in the Framing Diagram. Framing must be extremely square and plumb in order to accomplish a successful installation.

3. If wall board and finished materials for the wall enclosure have been determined, install hot and cold water supply lines with the control valve. Mount to the framing.

4. It is extremely important that the floor area intended for the installation be flat and level. Any areas over 1/8" out-of-level will prevent the installation from being successful. If an area out more than 1/8" is found, float the floor area with a floor leveling compound. This material must be placed and cured (dry) before proceeding with the shower installation.

5. *A special note: During handling and transport, the product may be slightly bent. It is very important that the threshold of the pan does not have any bow or bend. This product is engineered with materials that allow for the threshold to be pressed back to the normal and straight form it is intended.*



Figure 3

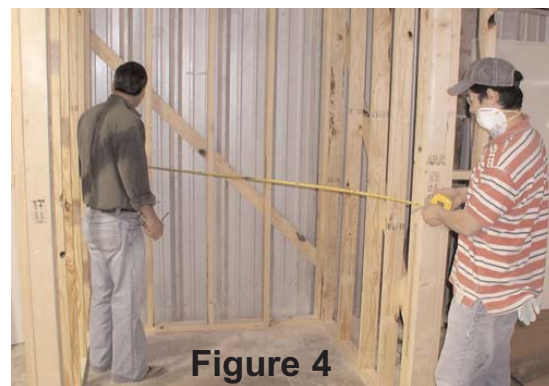

Figure 4



FRAMING DIAGRAMS

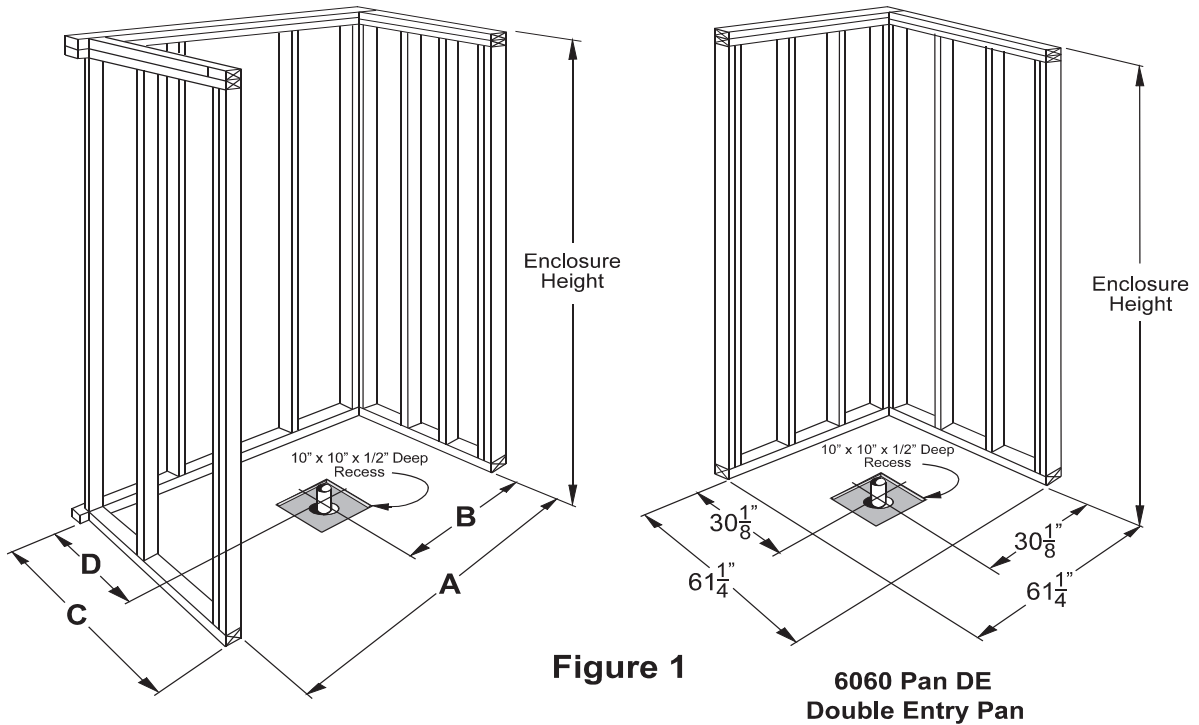

Figure 1

6060 Pan DE
Double Entry Pan

	A	B	C	D
3838	38 7/8"	19 7/16"	38 5/8"	19 1/8"
4836	48 1/4"	24 1/8"	37 1/4"	18 1/8"
6030 C	60 1/4"	30 1/8"	31 1/4"	15 1/8"
6030 L-R	60 1/4"	8 9/16"	31 1/4"	15 1/8"
6033 C	60 1/4"	30 1/8"	33 5/8"	15 1/8"
6033 L-R	60 1/4"	8 9/16"	33 5/8"	15 3/8"
6036 C	60 1/4"	30 1/8"	37 1/4"	18 1/8"
6036 L-R	60 1/4"	8 9/16"	37 1/8"	18 3/4"
6048	60 1/4"	30 1/8"	49 1/4"	24 1/8"
6060	60 1/4"	30 1/8"	61 1/4"	30 1/8"
6232	62 5/8"	31 5/16"	32 1/2"	16 3/8"
6238	62 5/8"	62 5/8"	38 1/2"	19 3/8"

DETAIL OF DRAIN CORE AREA

6" Diameter Drain Core
10" x 10" x 1/2" Deep
Recess Around Core

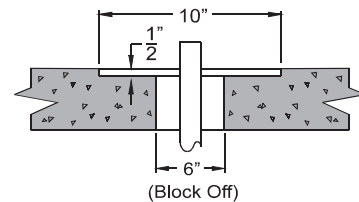

Note: Unit will not install properly if framing pocket is not square and of proper size. The dimensions shown in the FRAMING DIAGRAMS are 1/4" larger than the size of the shower pan. This product is manufactured to tight specifications. The 1/4" over sizing is for maneuvering and installation ease. If 1/4" over is not reasonable, sizing closer to the product actual dimensions is allowable.



Shower Pans Installation Instructions

Gelcoat & Solid Surface Bathware

When the shower pan is removed from the packaging, use a straight edge to check the straightness of the threshold.

Place a straight edge on the under side of the threshold across the front to check the straightness. See *Figure 2A*

In the event it is not straight to 1/16", pressure can be applied to the top side of the material. This can be accomplished by placing blocks under the two extreme corners of approximately 3" high.

Always place a soft rag on the finished surface where it contacts the wood blocks, and under your feet to avoid damaging the finish.

Gently step on this area and allow your body weight (Up to 250 pounds), to flex the material back straight. Confirm straightness, repeat if necessary until +/- 1/16" is accomplished. See *Figure 2B*

6. Carefully measure the framing pocket to assure it is of proper size for the unit to be installed. Refer to dimensional information in the *FRAMING DIAGRAMS- Figure 1*.

7. Check the framing pocket for square. Check to assure the vertical studs are plumb. Check for square by holding a measuring tape from the back left corner to the right front corner, as shown in *Figure 4*. Repeat for the other side. If both dimensions are the same, the framing is square. Adjust if necessary.

These steps are necessary to assure a good installation of the walls (provided by others) to be installed later:

8. The next step is to dry fit the shower pan to the studs and confirm the drain location.

The better fit of the pan, the better all wall parts will assemble as intended with minimal gaps at the seams.

Note in Figure 5 the two installers have placed the shower pan on the floor, and are pushing it into the installed position. One of the installers is using a short piece of 2 x 4 wood to hold the front of the shower pan off the floor. This will assist in moving the pan into the installed position while preventing chipping the front edge if it were to slide along the sub floor.

NOTE: There are 2 shower pans models that require



Figure 5



Figure 6

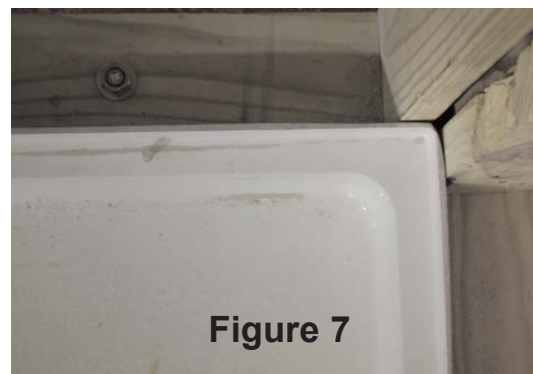

Figure 7



Figure 8



Shower Pans Installation Instructions

Gelcoat & Solid Surface Bathware

shims on the underside for installation. These models are: When the shower pan is trial fit in the framing pocket, shim under the leveling leg on the under side of the pan. Place the shims and adjust until the pan is level and does not rock. These shims must be glued or screwed down in the correct location before the final installation. This step is required for these units to assure a correct installation for these two higher threshold shower pans.

After the pan is set, fill any gaps between the mounting flange and the framing with wood shims or furring strips to achieve solid contact. The flange must be in contact with the studs along all sides.

The back corners of the shower pan should be in contact with the framing, as seen in *Figure 7*. Shim these areas if required.

9. Once the shower pan is put into place and fit is confirmed, draw a pencil line on the sub floor indicating the front point of the threshold of the pan. See *Figure 8*

Place a piece of cardboard in the floor of the shower to protect the floor during the additional steps of installation. There is a cut out for this on the pan box.

10. Confirm the pan is level by using a long level on top of the threshold, and along the sides and back. Note the level is used on the finished horizontal surfaces along the back and both sides. See *Figures 9A and 9B*

If the pan is not level, shim the appropriate areas to achieve level. Do not shim more than 1/8". If shimming over 1/8" is required, remove the pan and correct the sub-floor area by "floating" a floor leveling compound.

11. Drill holes through the mounting flanges into each framing stud. These holes should be drilled using a 1/8" drill bit. See *Figure 10*

Note: Plan on using flat or pan head screws to secure the shower pan. A minimal screw head exposure will allow for easier installation of wall board and finished wall materials. (Wall materials furnished and installed by others).

12. The next step is to permanently install the shower pan. A helpful tip to make this easier is to rotate the pan upward and lean against the back framing studs of the pocket. This will remove the pan from the work zone without removing it from the stud pocket. Do not secure



Figure 9A



Figure 9B

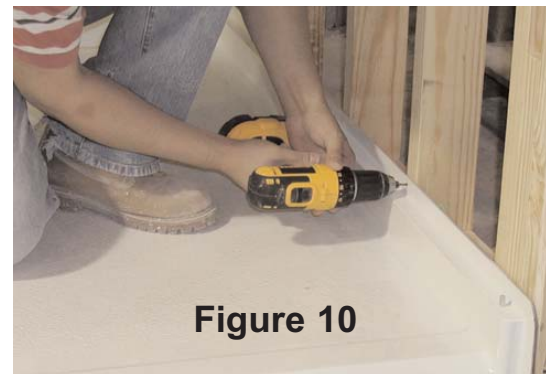

Figure 10



Figure 11



Shower Pans Installation Instructions

Gelcoat & Solid Surface Bathware

the pan to the studs at this point because you may need to reach around the pan as you install the drain fitting detailed in the next step. Make sure pan is angled enough so it will not fall.

13. Install the drain fitting on the shower pan. Apply a bead of 100% silicone caulking around the recessed molded drain area on the finished side of the pan. Remove the nut and all gaskets from the drain body. Slip the threaded shank of the drain body through the hole. Follow the instructions provided with the drain fitting to install the gaskets in the proper location. When all gaskets and Locknut are in place on the bottom side of the shower, tighten the nut to secure the shower drain assembly. From the top side of the drain assembly, remove the rubber caulking gasket that will fit around the drain pipe until the installation is complete. This will allow the drain pipe to slip with the floor slope unit it is properly braced.

A diagram of a typical drain assembly is shown in this manual.

Wipe away any excess caulking that may have squeezed out on the inside of the pan.

Now secure the pan in the upright position to the back framing. Use a piece of scrap 2 x 4 lumber to temporarily secure it. See the example in Figure 12

14. A solid wood floor adhesive will be used to “glue” the bottom side of the shower pan to the sub floor. The following steps will detail the appropriate steps to accomplish this.

NOTE: Models 4836 SH Pan and 6030 SH Pan are not glued as described above. The models must have the bottom supported by shims placed under the leveling legs at the underside of the pan. This step is described on Page 5 Step 8. If installing these models, the following instructions referring to adhesive do not apply.

15. Clean the sub-floor thoroughly, wiping away all loose debris. Wipe up any moisture. Never use adhesive on a dirty or

16. To secure the shower pan to the floor a solid wood floor adhesive must be applied to the entire sub floor area where the shower pan will rest.



Figure 12

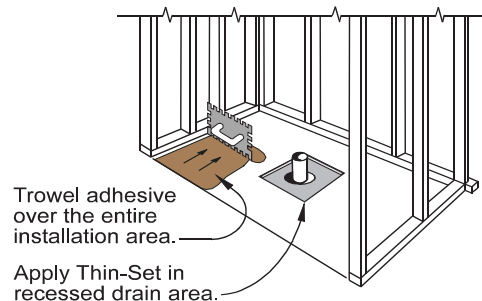

Figure 13A

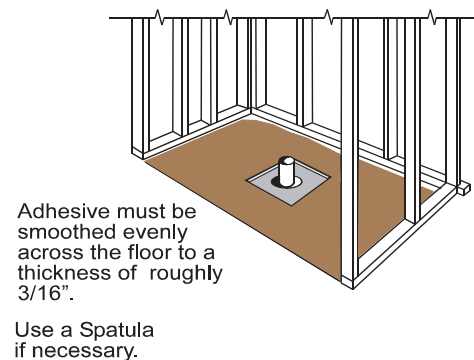

Figure 13B



Shower Pans Installation Instructions

Gelcoat & Solid Surface Bathware

Using a 1/2" notched trowel, apply adhesive evenly over the pan contact area. Bring the adhesive up to the threshold pencil mark and also make sure the adhesive will be in contact with the back side of the pan. The long edge of the trowel may be needed to get the adhesive to the far back of the contact area where the pan is resting against the framing studs in a vertical position.
(Pan not shown in Figures 13 A and B).

After the adhesive is troweled over the sub floor, use a spatula to wipe the adhesive over the entire area where the pan will sit.

The exception will be the drain box area. This area will be filled with thin-set non shrink mortar. Do not fill this area above the floor line and do not spill any of this thin-set material onto the contact adhesive. See Figure 13B

Non shrink thin-set mortar can be purchased at the local hardware store. Please follow the mixing directions on the bag.

In this step, apply the adhesive to the flat floor area and fill the boxed area around the drain pipe with the Thin-Set mortar.

17. After the adhesive and thin-set materials are in place, rotate the pan back into place for installation.

(Hint) In order to reach the pan without stepping on the adhesive, place a short piece of wood over the drain area. Use this to step on to remove the 2 x 4 that is holding the pan against the back framing. See Figure 14

NOTE: The working life of the flooring adhesive is roughly one hour. (Refer to the label on the adhesive for actual working time). After step 16 is complete, the entire installation process through step 21 must continue. If for any reason the installation cannot be completed within the working time of the adhesive, after step 16, jump ahead to step 21.

Rotate the pan back to the horizontal position. As you lower the pan to the sub floor, align the drain pipe with the drain fitting, and with the pencil mark at the front of the threshold.

When the pan is seated into the adhesive, place the cardboard on the shower floor for protection. Thoroughly walk around in the shower. This will assist in seating the pan



Figure 14



Figure 15

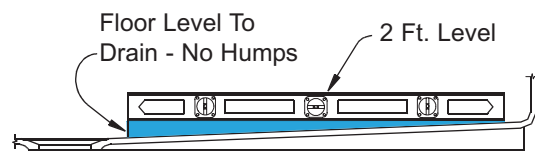
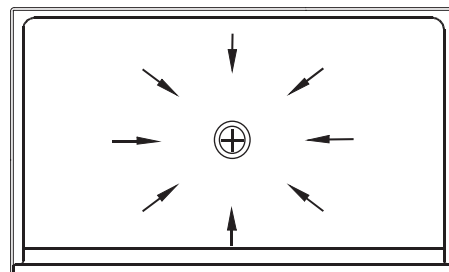

Figure 16A



Level in all directions around the drain to assure good drainage.

Figure 16B



Shower Pans Installation Instructions

Gelcoat & Solid Surface Bathware

into the adhesive.

Attach the pan to the studs by installing the screws through the holes drilled into the flange. Snug the screws up tight but not to the point of flange breakage. The screws must be tight so they will not interfere when the wall board and finished walls materials are installed.

18. Before moving on to installing the shower wall enclosure, level the pan as shown in *Figure 15*. The shower pan has minimal slope to the drain, and must be very level to drain properly. Use a long level along all finished edges. If there is an out of level condition, remove screws and adjust the shower pan. When satisfied with the fit, re-install the mounting screws.

19. Before the adhesive cures, confirm the floor slope to the drain has been maintained. To do this, remove the cardboard protection from the floor and use a 2 foot level at various points around the drain to the adjacent wall to check for draft. Make sure there is a downward slope to the drain in all directions around the drain. Visually inspect the floor to be sure there are no humps or dips that could cause improper drainage. See *Figure 16A and 16B*

20. Install the rubber caulking gasket around the drain pipe. Trim the length of the pipe if necessary. Apply soap to the caulking gasket to lubricate it. Place the caulking gasket on the drain pipe and press it down into the drain assembly until it seats. Snap the strainer plate onto the drain.

Pour water across the floor to confirm good draft to the drain so the water drains completely with no puddling. Make certain the drain does not leak.

Note: *The manufacturer and supplier of this product is not responsible for leaking drain conditions. Proper installation of the drain fitting and pipe is the installers responsibility.*

21. Since there is minimal floor slope to the drain it is critical factory slope to the drain is maintained so the shower drains well. To accomplish this, temporary bracing must be put in place to assure the floor remains in the proper position as the adhesives cures. Before installing the bracing, place a padded piece of wood on the top center of the threshold and directly on top of the drain. Pad the wood with soft cloth or cardboard to prevent damage to the finish.

Install temporary 2 x 4 stud bracing so they sit on top of

these wood pieces. Attach these studs to the room framing above the shower, or pad to the ceiling as shown. See *Figure 17*

After 72 hours, remove the bracing.

The shower pan installation is now complete.

The water resistant wall enclosure is provided by others. The installer must develop a plan to ensure the chosen wall materials work with the fiberglass shower pan. The seam between the shower pan and the finished wall materials should be caulked when installation is complete. Before beginning construction of the shower wall enclosure, place

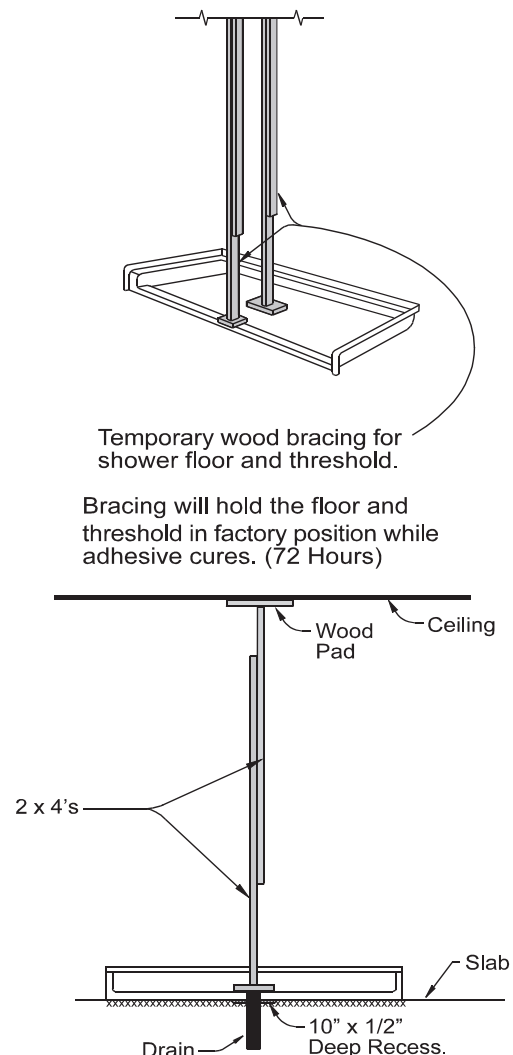

Figure 17



Shower Pans Installation Instructions

Gelcoat & Solid Surface Bathware

a drop cloth or card board on the floor of the shower pan to protect the gelcoat surface.

Remember to install wood reinforcements to the framing for grab bars and seat, should these bolt on accessories be installed. A procedure for installing a fold up seat to a ceramic tile wall is described.

INSTALLATION INSTRUCTIONS FOR SHOWER SEATS WITH SWING DOWN LEGS

(This style seat has four (4) adjustable height legs)

These primary instructions are for installing the seat onto a CERAMIC TILED WALL. The tiles wall must be properly constructed so as to be rigid. In addition, it is MANDATORY that wood reinforcements be installed to the framing studs behind the wall board and tile to provide a solid mounting surface when fastening the seat to the wall.

Your seat with swing down legs is fully assembled. Remove it from the box and proceed as follows:

1. Choose the height of the seat you want. Barrier Free style showers will typically have fold up seat installed at 17" to 19" height.
2. After selecting the height you desire, adjust each of the four legs to that height while maintaining the seat in a level position. Lock each of the lock nuts.
3. Place the seat against the wall of the shower where you want the seat to be located. Seat may be centered on the wall for a Barrier Free installation.
4. With the seat placed against the mounting wall, position the two hinges to the wall. Using a pencil, mark the three holes (3) holes in the flange onto the wall for each hinge. Remove seat from wall.

Note: When installing the seat onto a Ceramic Tiled wall, prior to drilling the three (3) mounting holes for each flange that you previously marked, use a center punch and lightly chip a small hole in the center of each of the three hole locations. (For drilling holes through tile, you require a 1/4" Carbide tipped drill bit). Only drill through the tile and base materials. DO NOT DRILL THROUGH THE BACKING.

5. Using a power drill with a 1/4" diameter Carbide bit, drill through the wall tile the three (3) mounting holes for each flange.

6. Apply silicone caulking around and inside each drilled hole before installing the seat.

7. Place the seat against the mounting wall with each hinge aligned to the mounting holes. Utilizing the six (6) #10 x 2" Stainless Steel screws, place a Phillips screw driver into your power drill and securely tighten each of the six (6) screws.

THIS COMPLETES THE INSTALLATION OF THE SEAT



Shower Pans Installation Instructions

Gelcoat & Solid Surface Bathware

INSTALLATION INSTRUCTIONS FOR GRAB BARS

Recommended tools for installation:

1/4" Power Drill

1/8" drill bit when drilling through fiberglass

(Use a 1/4" Carbide drill bit when drilling through ceramic tile)

#2 Phillips Screw Driver and/or Phillips drill insert

1/2" Open end wrench or a small Crescent wrench

Tape measure

Pencil/pen

Center Punch

Silicone Caulk

1. As indicated earlier in this manual, wood reinforcements must be solidly installed behind the tile wall surface to provide a secure mounting surface to attach the grab bars. Grab bars must be installed at these locations only.

2. Select the particular size and style of grab bar you want to install. Certain grab bars have snap in place flange covers, and others have exposed flanges.

3. For grab bars with snap in place flange covers, use the handle of a Phillips screw driver to tap back the covers on the bottom edge of the covers. It will be convenient in the installation process if the covers are tapped together in the center of the grab bar.

4. Determine the position you want the to install the bar. Place the bar against the wall. Using a pencil, mark the location of each mounting hole at both ends of the bar.

Note: When installing the grab bars onto a CERAMIC TILED WALL, prior to drilling the mounting holes for each flange previously marked, use a center punch and lightly chip a small hole in the center of each hole location. (for drilling through ceramic tile, you require a 1/4" carbide tipped drill bit. Only drill through the tile and base materials. DO NOT DRILL THROUGH THE WOOD REINFORCEMENTS

5. Using a power drill with a 1/4" diameter carbide tipped drill bit, drill, each mounting hole.

6. Apply silicone caulking around and inside each drilled hole before installing the grab bar.

7. Take two (2) of the #10 x 2" Stainless Steel screws. By hand, start one mounting screw in each end of the bar into the wall.

8. Use a power drill with a Phillips drill bit to fully install these mounting screws.

9. Take the remaining #10 x 2" screws and place them into the remaining open holes. Use care to snug up the screws, but to not over-torque that the screws strip out the factory installed backer board.

10. If installing a bar with snap-on covers, move the covers into place at each flange. Twist the covers clockwise or counter clockwise to tighten the covers onto the flanges.

THIS COMPLETES THE INSTALLATION OF THE GRAB BAR

CURTAIN ROD

The curtain rods are shipped at standard length. Measure your opening width for proper length. Measure and mark the curtain rod, using a skill saw with a cutting blade for metal product, cut at the marked area.

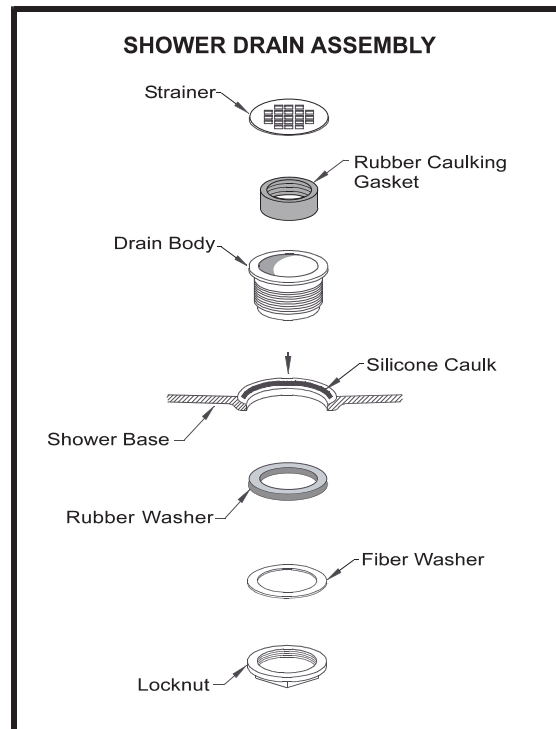

© 2013, The Praxis Companies, LLC
435 Industrial Rd., Savannah, TN 38372
Customer Service: 800.443.7269
www.praxiscompanies.com



Semi-Permanent Removable Threshold Installation Instructions

Gelcoat & Solid Surface Bathware

Tools you might need for proper installation

- Pencil
- Grinder or Sander
- Mildew Resistant Bonding Silicone (white)
- Caulk Gun and White Caulk
- Tape Measure
- Two (2) 5"x 5" Cardboard Samples
- Removable Masking Tape

Threshold Part Numbers

- ITHR60
- ITHR48
- ITHR36

Available only in white

PRODUCT MATERIAL AND STRUCTURE

Non-porous ABS cap mounted to a super strong PVC substrate that will match both gelcoat and acrylic bathware.

Thank you for purchasing the Praxis Semi-Permanent Removable Threshold. For best results, please read and follow all directions carefully.

CUSTOMIZING THE SEMI-PERMANENT THRESHOLD

1. Place the semi-permanent threshold into shower to test fit. Although the semi-permanent threshold is pre-cut at the manufacturer, modifications may be necessary for a custom fit. **(FIG. A)**

2. Mark area that needs adjustment with a pencil. **(FIG. B)** A small piece of cardboard can be used to trace the radius of the area and can then be used as a template or guide to modify the corners of the semi-permanent threshold to ensure a good fit. **(FIGS. C-D)** Grinding or sanding the corners will assure a custom fit and installation. **(FIG. E)**

3. After making the necessary modifications, place the



threshold back into the shower to ensure all modifications are correct and dry fitting the threshold is accurate.

4. You are now ready to install the threshold into the shower.

INSTALLATION OF SEMI-PERMANENT THRESHOLD

1. Using a Mildew Resistant bonding silicone (white), place a bead of caulking around the underside parameters of the threshold. **(FIG. F)** Position threshold into place. **(FIG. G)** Remove excess caulking and smooth with wet finger or caulking pallet.

2. Apply a thin bead of caulking around the top side of the finished threshold to seal between the shower and threshold. **(FIG. H)** The silicone used in Step 1 is

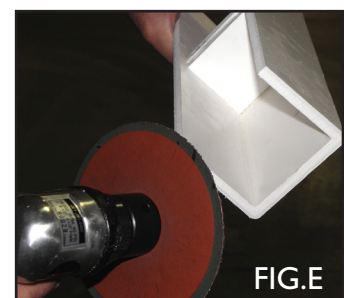
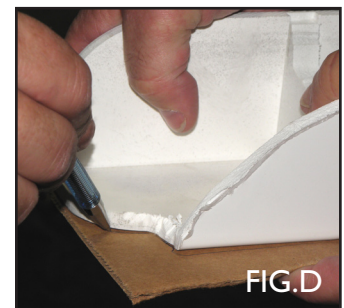
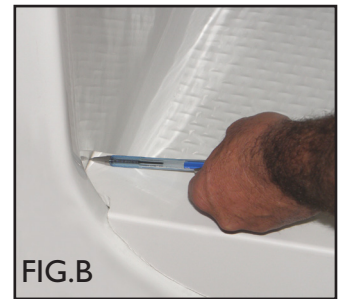



Semi-Permanent Removable Threshold Installation Instructions

Gelcoat & Solid Surface Bathware

to seal and secure into place. Caulk should be used for a more aesthetically pleasing look.

3. Using the removable masking tape, secure the threshold in place taking care not to shift. Silicone will take 24 hours to dry and become firm. Bathware should not be used during drying time.

ATTENTION:

On model numbers: A4136 or S4136 – You must bevel the bottom inside of the threshold to allow it to seat properly to the shower. (FIG. I)

For shower pans: The threshold will be cut to length, however the corners will need to be slightly rounded. (FIG. E)

© 2013, The Praxis Companies, LLC
435 Industrial Rd., Savannah, TN 38372
Customer Service: 800.443.7269
www.praxiscompanies.com

