

Talis S
Prep Kitchen Faucet, 2-Spray Pull-Down, 1.75 GPM
 Finishes : **steel optic** Part no. : **72815801**



Description

Features

- Swivel range 110° / 150°
- Laminar and needle spray
- Toggle spray diverter
- MagFit magnetic sprayhead docking
- Single-hole installation
- Flow: 1.75 GPM (6.6 L/Min)
- Ceramic cartridge
- 3/8" connections
- Integrated double backflow prevention

Item details

List Price \$ 643.00

Technology



Compliance

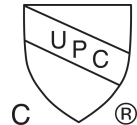

Product image



Scale drawing

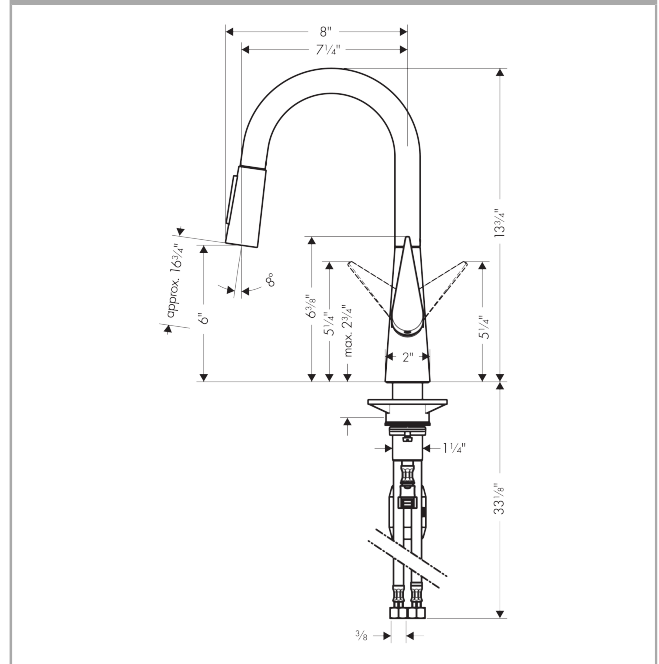

Talis S
Prep Kitchen Faucet, 2-Spray Pull-Down, 1.75 GPM
 Finishes : **steel optic** Part no. : **72815801**



Exploded drawing

Year of production: >01/18

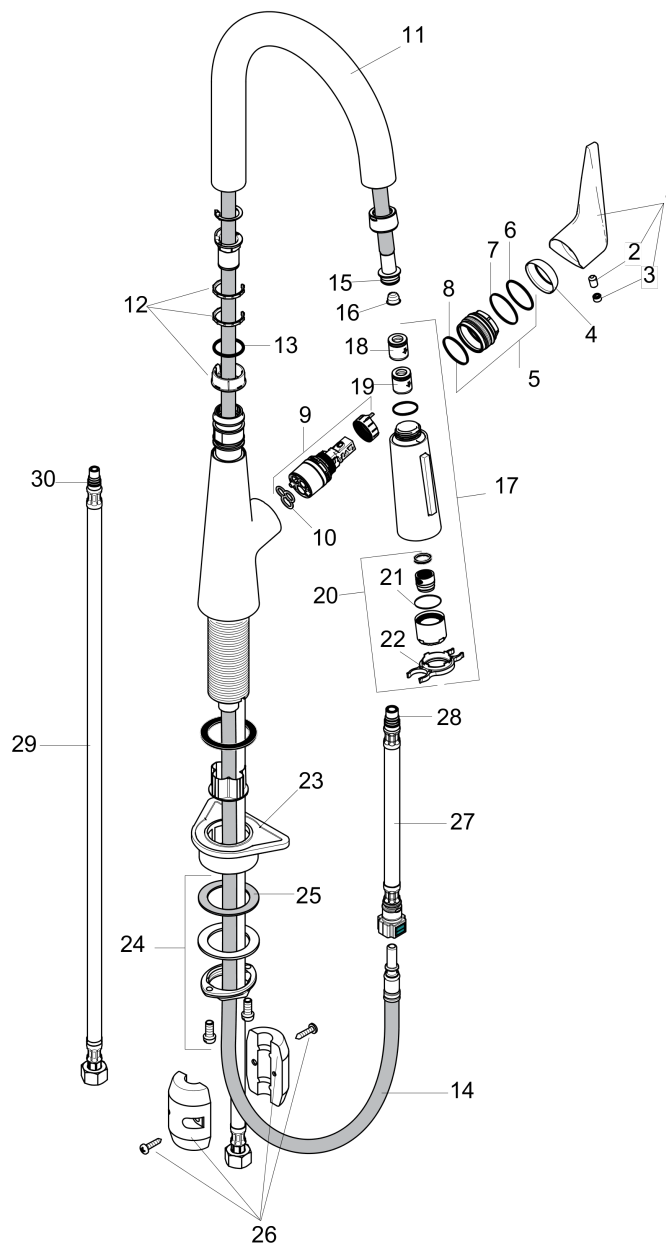

Talis S

Prep Kitchen Faucet, 2-Spray Pull-Down, 1.75 GPM

Finishes : **steel optic** Part no. : **72815801**



Spare parts list

Year of production: >01/18

Pos.	Description	Part no.	Price	PU
1	handle	93148800	-	1
2	hollow set screw M6x10 DIN 916	96029000	-	1
3	screw cover	95704000	-	1
4	flange	95493800	-	1
5	nut	98864000	-	1
6	O-ring 23x2	98398000	-	1
7	O-ring 27x1,5	92527000	-	1
8	O-ring 25x1,5	98146000	-	1
9	cartridge, assy	97685000	-	1
10	seal	98865000	-	1
11	spout cpl.	93159800	-	1
12	set of lever collars	98365000	-	1
13	O-ring 21x2,5	98211000	-	1
14	hose 1,25 m	95506000	-	1
15	O-ring 11x2	98127000	-	1
16	filter	97735000	-	1
17	handspray	92732800	-	1
18	non return valve	93218000	-	1
19	set of non return valves DW 15	94074000	-	1
20	aerator laminar M22x1 (15 l/min)	95909000	-	1
21	O-ring 20x1	98140000	-	1
22	service tool	95910000	-	1
23	support	97523000	-	1
24	fixing set (Ø 34)	95049000	-	1
25	lever collar	97548000	-	1
26	weight	98551000	-	1
27	connection hose 600 mm M10x1	95561000	-	1
28	O-ring 8x1,75	97827000	-	1
29	connection hose 35½" M8x0,75 3/8"	96316001	-	1
30	O-ring 7x1,5	98422000	-	1