

Ecostat S
Pressure Balance Trim
 Finishes : **brushed nickel** Part no. : **15739821**



Description

Features

- Flow: 5.5 GPM (20.6 L/Min)
- Integrated bypass for use with diverter tub spouts
- Temperature and on/off control for 1 outlet

Item details

List Price \$ 288.00

Compliance

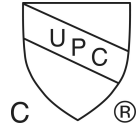

Product image



Scale drawing

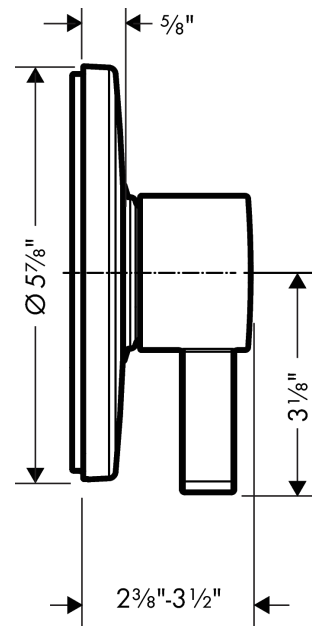

Ecostat S

Pressure Balance Trim

Finishes : **brushed nickel**

Part no. : **15739821**



Exploded drawing

Year of production: **>07/18**

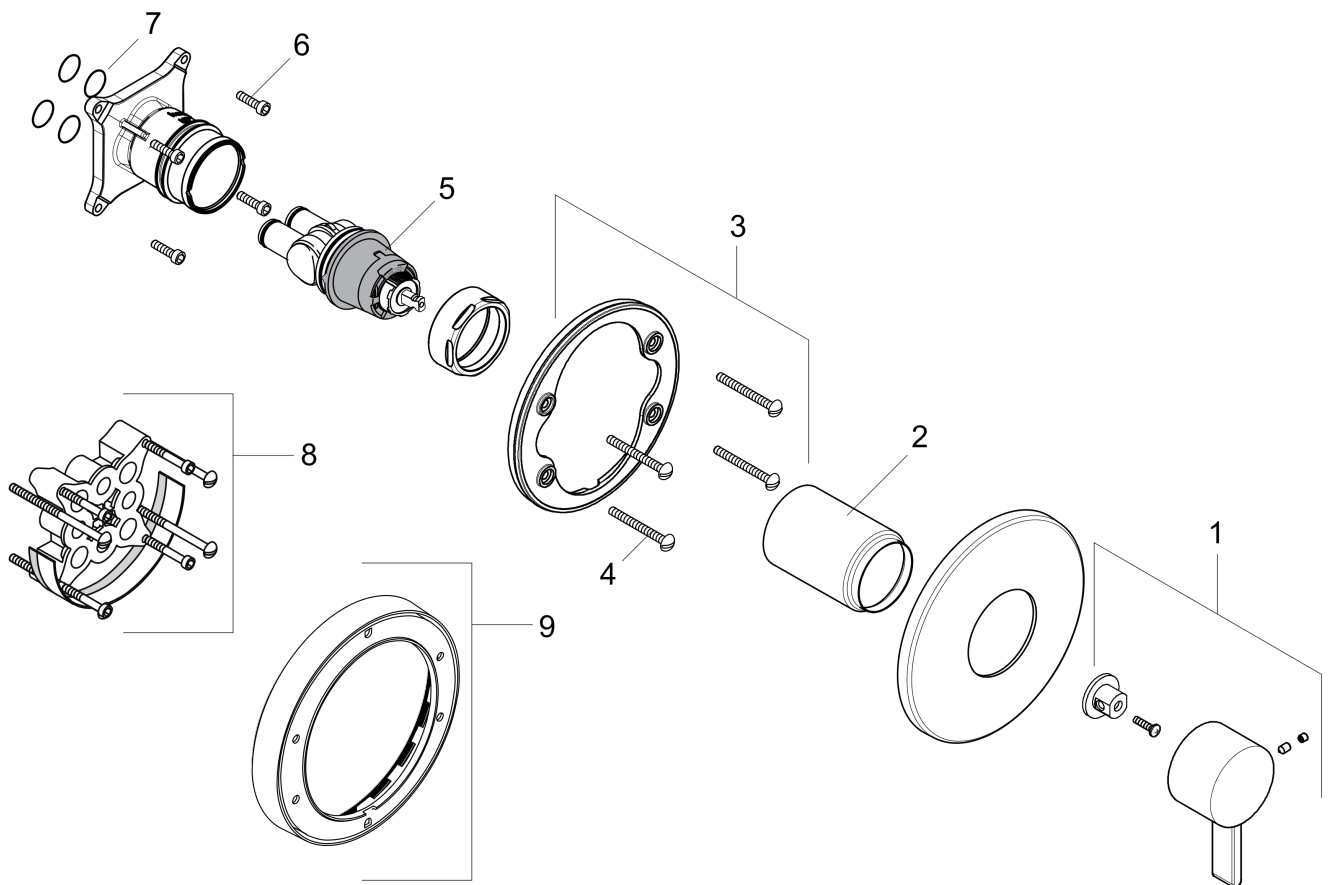

Ecostat S

Pressure Balance Trim

Finishes : **brushed nickel** Part no. : **15739821**



Spare parts list

Year of production: >07/18

Pos.	Description	Part no.	Price	PU
1	handle	88763820	-	1
2	sleeve	88765820	-	1
3	holder for escutcheon	98793000	-	1
4	set of fixing screws	96454000	-	1
5	cartridge, assy	88727000	-	1
6	set of screws	96525000	-	1
7	O-ring 16x2	98133000	-	1
8	extension 25 mm	13595000	-	1
9	extension 22 mm (Ø 150 mm)	13597820	-	1