

BATHROOM
 Vignola Deck-Mounted Tub Filler
 (Rough & Trim)
G-11659-LM60



Information

- Deck-mount installation
- Aerated spout flow rate ~7 gpm @ 45 psi
- Handshower flow rate ≤1.5 max gpm
- 8-7/8" spout reach
- Includes handshower with 59" spiral flexible hose (PVD finishes use 59" flex hose)

Finishes

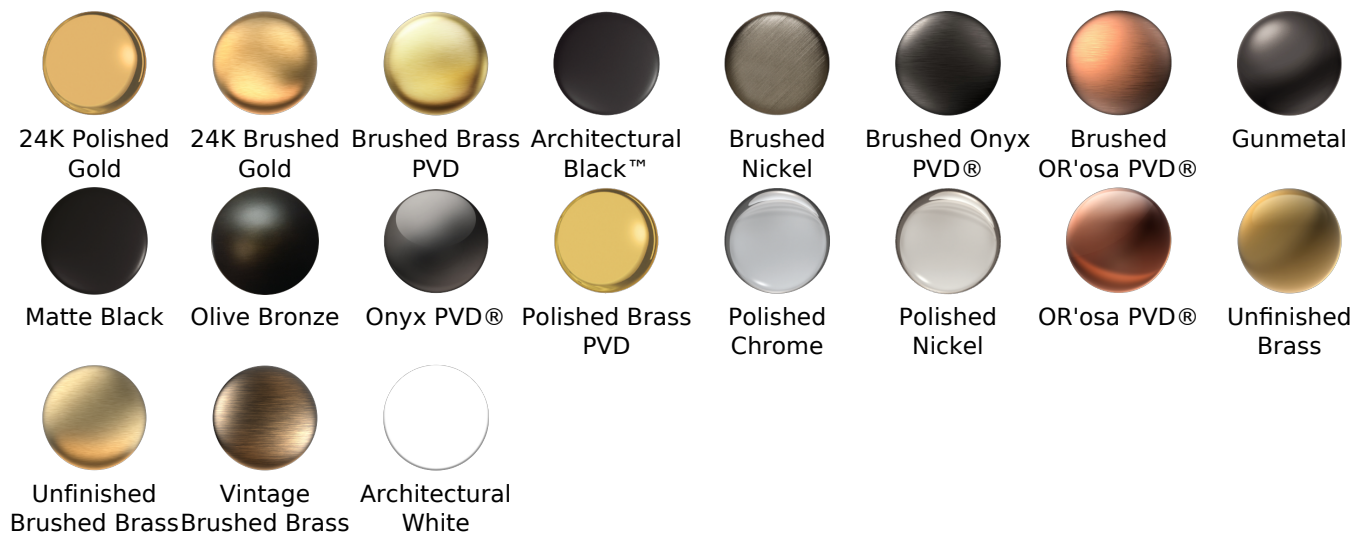

G-11659-**-LM60B

VIGNOLA Series

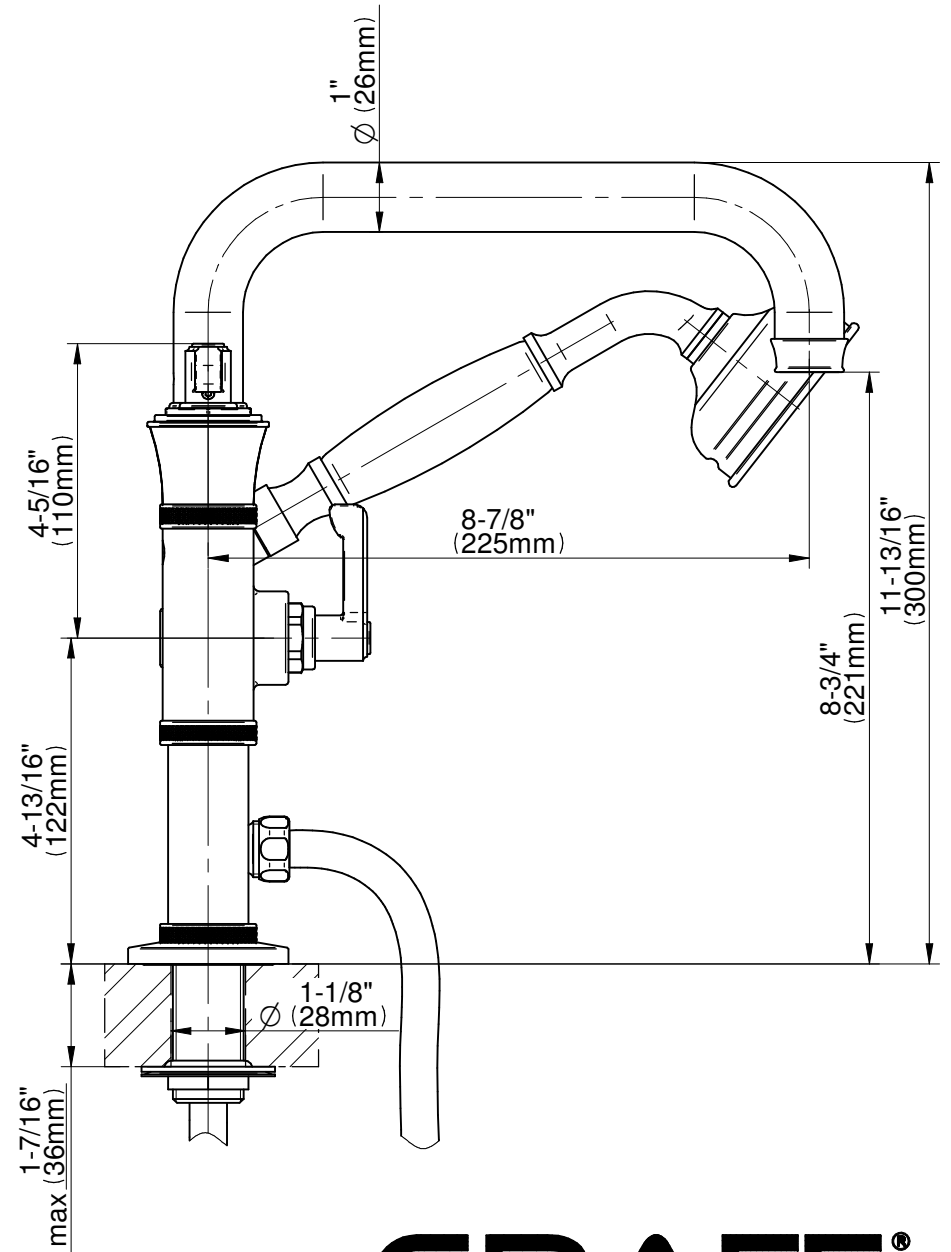
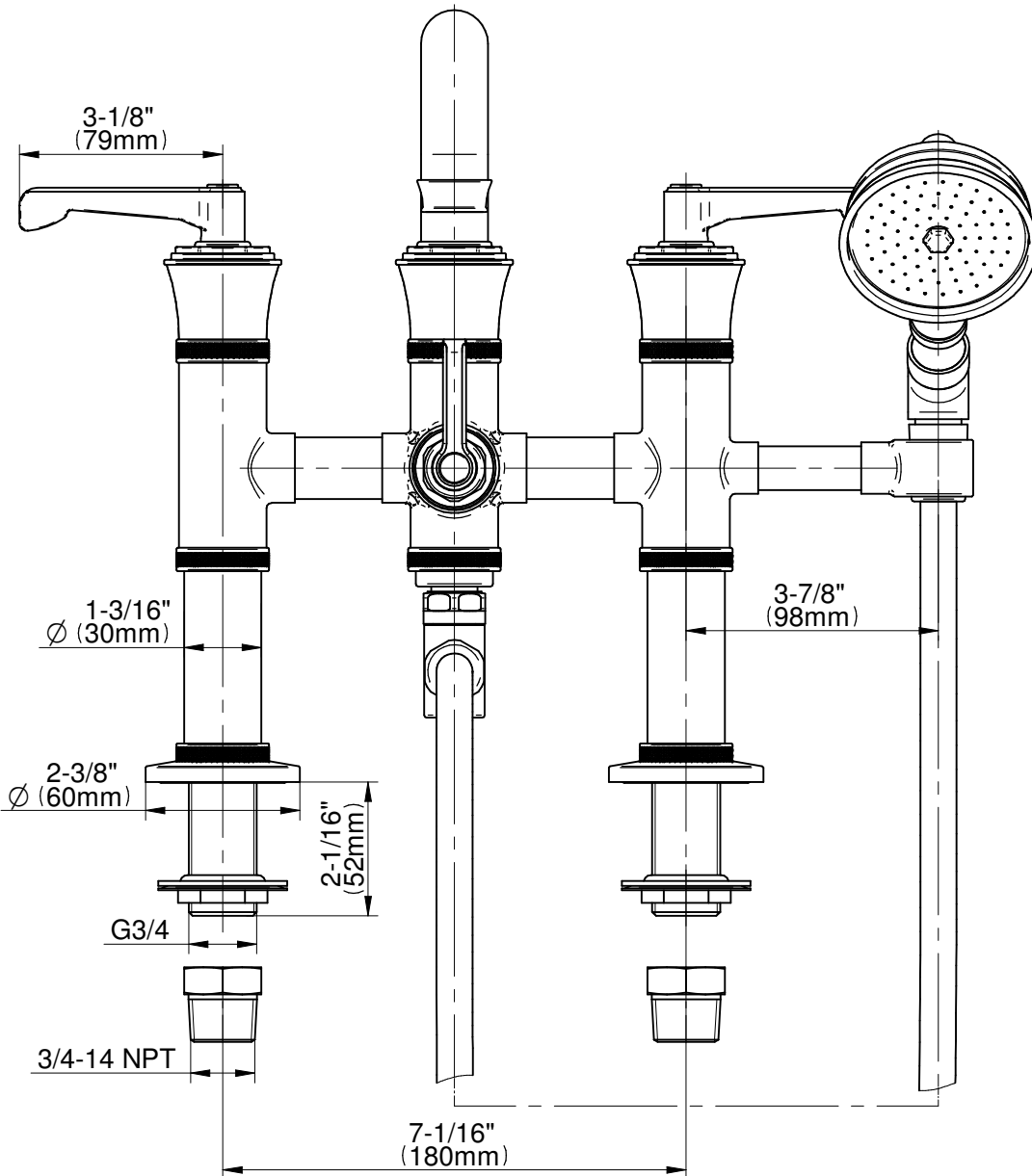

GRAFF®
Art of Bath