

BATHROOM
MOD+ Pressure Balancing Valve
Trim with Handle and Diverter
G-7080-T

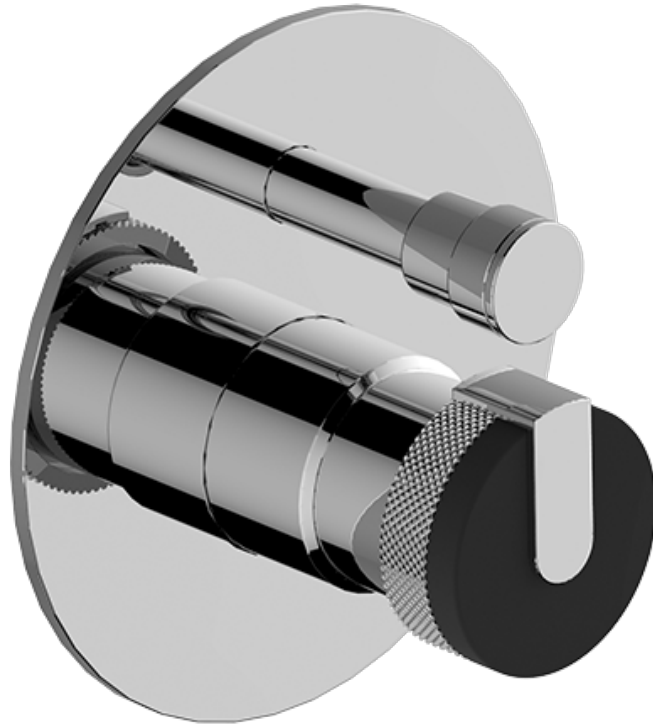









GRAFF®

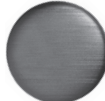

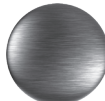





MARBLE FINISHES

MB		Storm Black Marble	MG		Forest Green Marble
MW		Smoky White Marble			

BRASS SIGNATURE FINISHES

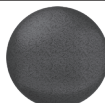
PC		Polished Chrome	OB		Olive Bronze™
BNi		Brushed Nickel	GM		Gunmetal
PN		Polished Nickel	VBB		Vintage Brushed Brass
UBB		Unfinished Brushed Brass			
UB		Unfinished Brass			
MBK		Matte Black (Available Spring 2019)			
BK		Architectural Black™			
WT		Architectural White			

RG		OR'osa PVD™	AU		24K Gold Plated
OX		Onyx PVD™	BAU		Brushed 24K Gold Plated
PB		Polished Brass PVD	GMD		Gunmetal Distressed
BB		Brushed Brass PVD			

STEP A

Select the spout style



See page 128

See page 128



See page 128



See page 131



STEP B

Select handle cover and finish

R2MB  STORM BLACK MARBLE

R2MW  SMOKY WHITE MARBLE

R2MG  FOREST GREEN MARBLE

RI**  BRASS WITH ANY SIGNATURE FINISH
PC, BNi, PN, UBB, UB, MBK, BK, WT, SN, OB, GM, VBB, RG, OX, PB, BB, AU, BAU, GMD

STEP C

Select the clip finish from GRAFF signature finishes LI**

PC 

BNi 

PN 

UBB 

UB 

MBK 

BK 

WT 

OB 

GM 

VBB 

RG 

OX 

PB 

BB 

AU 

BAU 

STEP D

Select the spout and handle base finish from GRAFF signature finishes

PC 

BNi 

PN 

UBB 

UB 

MBK 

BK 

WT 

OB 

GM 

VBB 

RG 

OX 

PB 

BB 



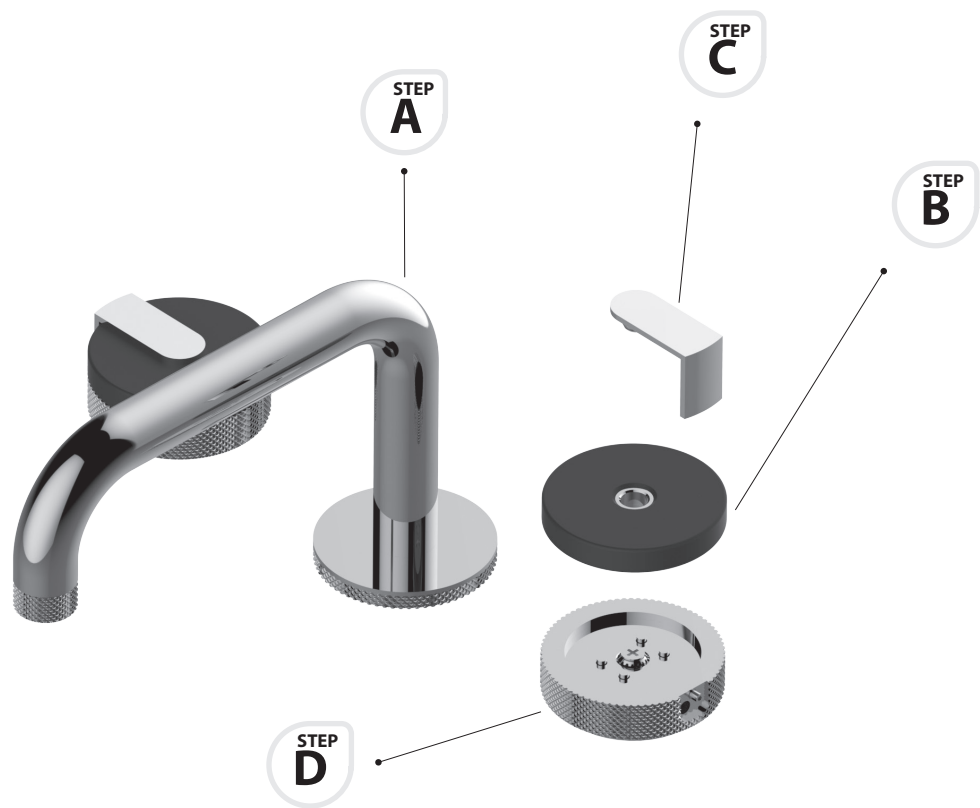

AU 

BAU 

example: G-11510-RIBK-LIAU-PC





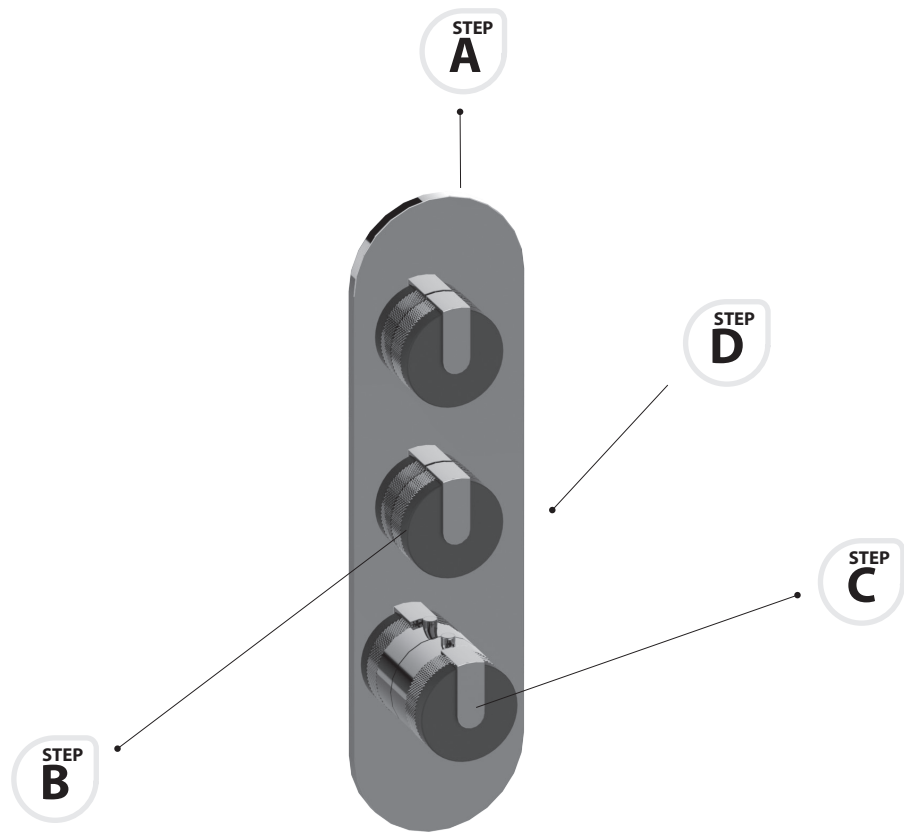

(A) G-11510 - (B) handle cover finish - (C) clip finish - (D) spout and handle base finish

<p>STEP A</p>  <p>See page 128</p>	<p>STEP B</p> <p>RIBK  BRASS WITH BK SIGNATURE FINISH</p>	<p>STEP C</p> <p>LIAU </p>	<p>STEP D</p> <p>PC </p>
--	---	--	--

example: G-8033-RIBKE0-LIPC-PC-T

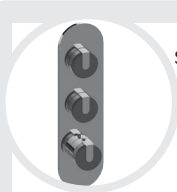

(A) G-8033- (B) handle cover finish - (C) clip finish - (D) plate and handle base finish

<p>STEP A</p>  <p>See page 142</p>	<p>STEP B</p> <p>RIBKE0</p>  <p>BRASS WITH BK SIGNATURE FINISH</p>	<p>STEP C</p> <p>LIPC</p> 	<p>STEP D</p> <p>PC</p> 
--	--	--	--