

BATHROOM
Targa Floor-Mounted Tub Filler
w/Wall-Mounted Handshower &
Diverter
G-3653-C14U

GRAFF®



Information

- Floor-mount installation
- Aerated Flow Rate ~9 gpm @45 psi
- 9-7/8" spout reach
- 33-1/2" - 36-5/8" ~spout height
- Optional in-line pressure balancing valve
- Handshower flow rate ≤ 1.5 max gpm

G-3653

TARGA Series

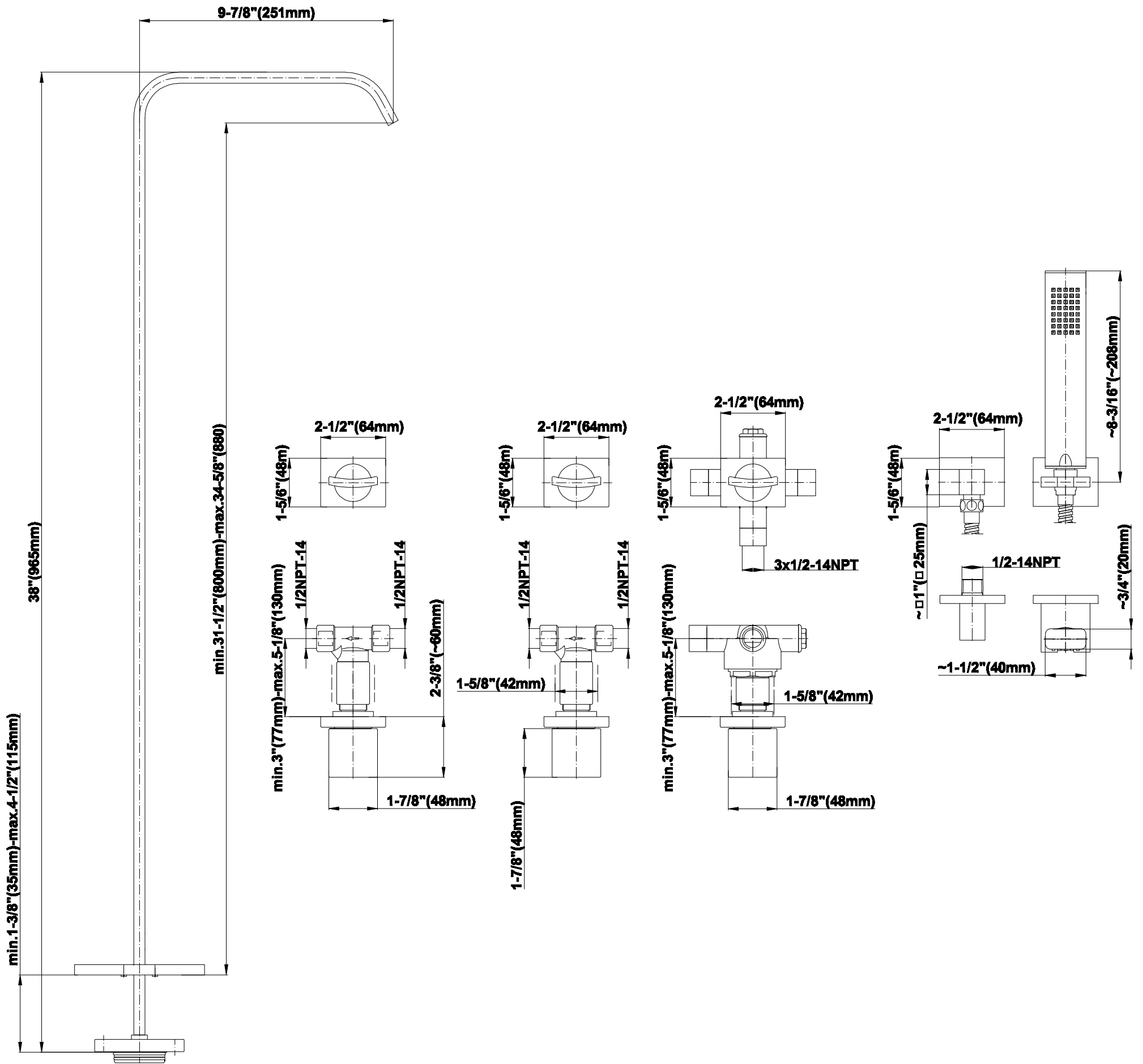

BATHROOM
Sade/Targa/Luna Tub Handle Set -
Wall-Mounted
C14U-BS

GRAFF®

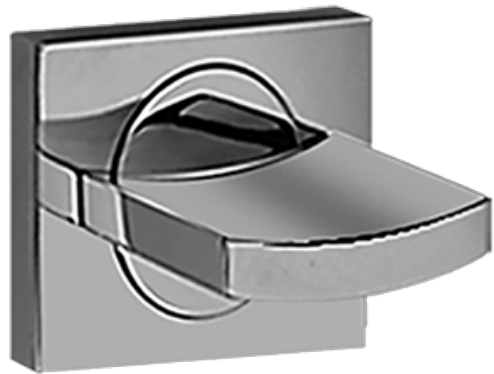
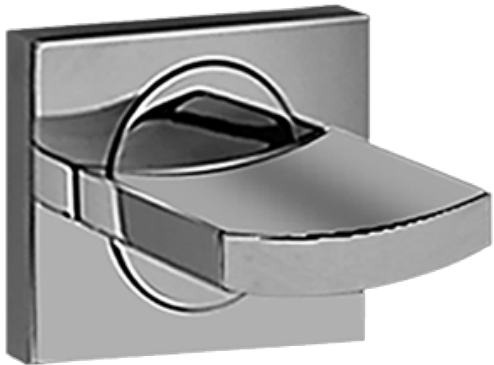

Finishes



24K Gold



24K Brushed
Gold



Architectural
Black™



Brushed
Nickel



Matte Black



Polished
Chrome



Polished
Nickel



Steelnox®
(Satin Nickel)

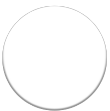

Architectural
White

C14U-BS, VS, WS

LUNA, SADE, TARGA Series

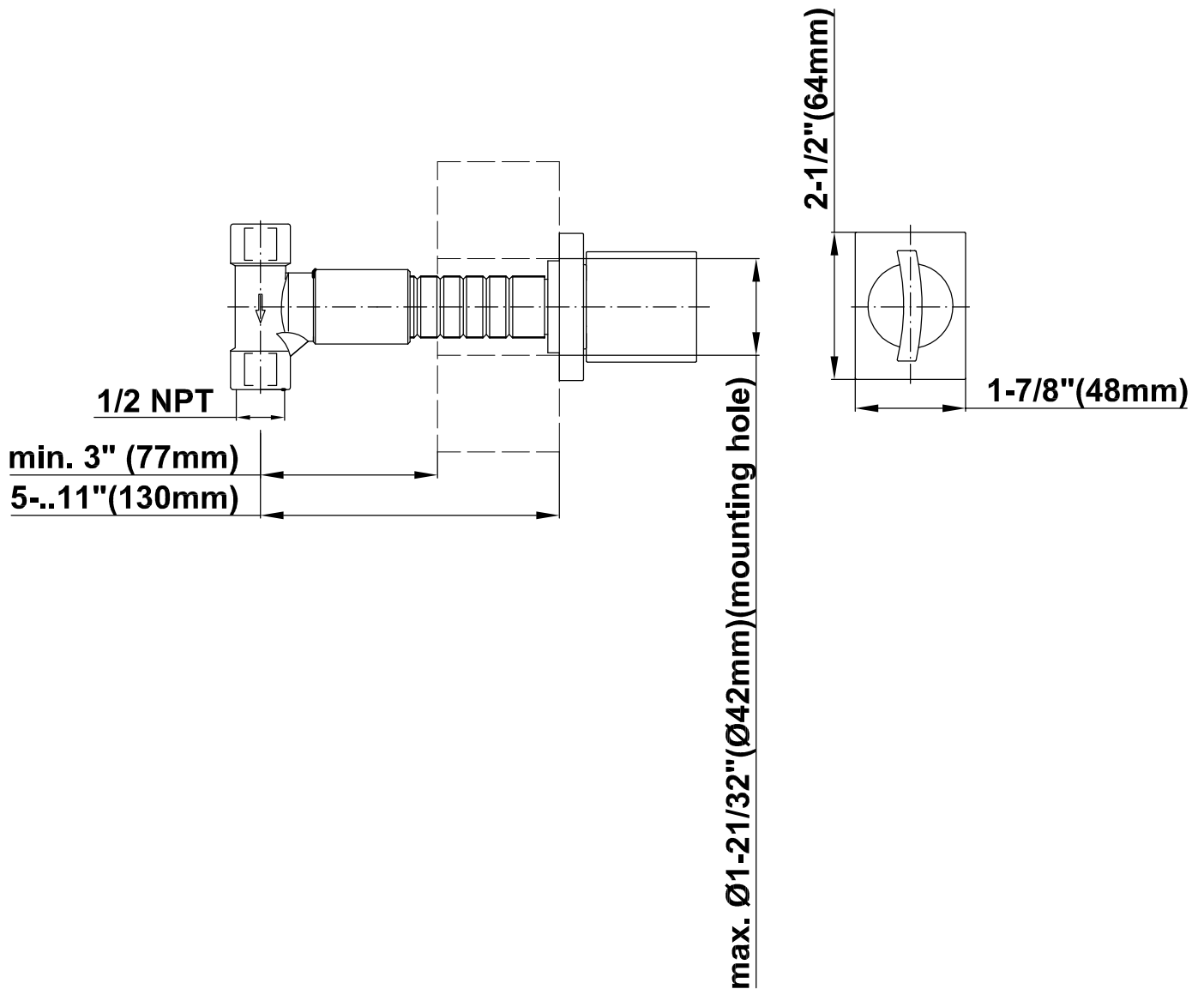

BATHROOM
Spout Connection Rough
G-1050

GRAFF®



Finishes



24K Gold



24K Brushed
Gold



Architectural
Black™



Brushed
Nickel



Matte Black



Polished
Chrome



Polished
Nickel



Stainless Steel®
(Satin Nickel)



Architectural
White

G-1050

Rough

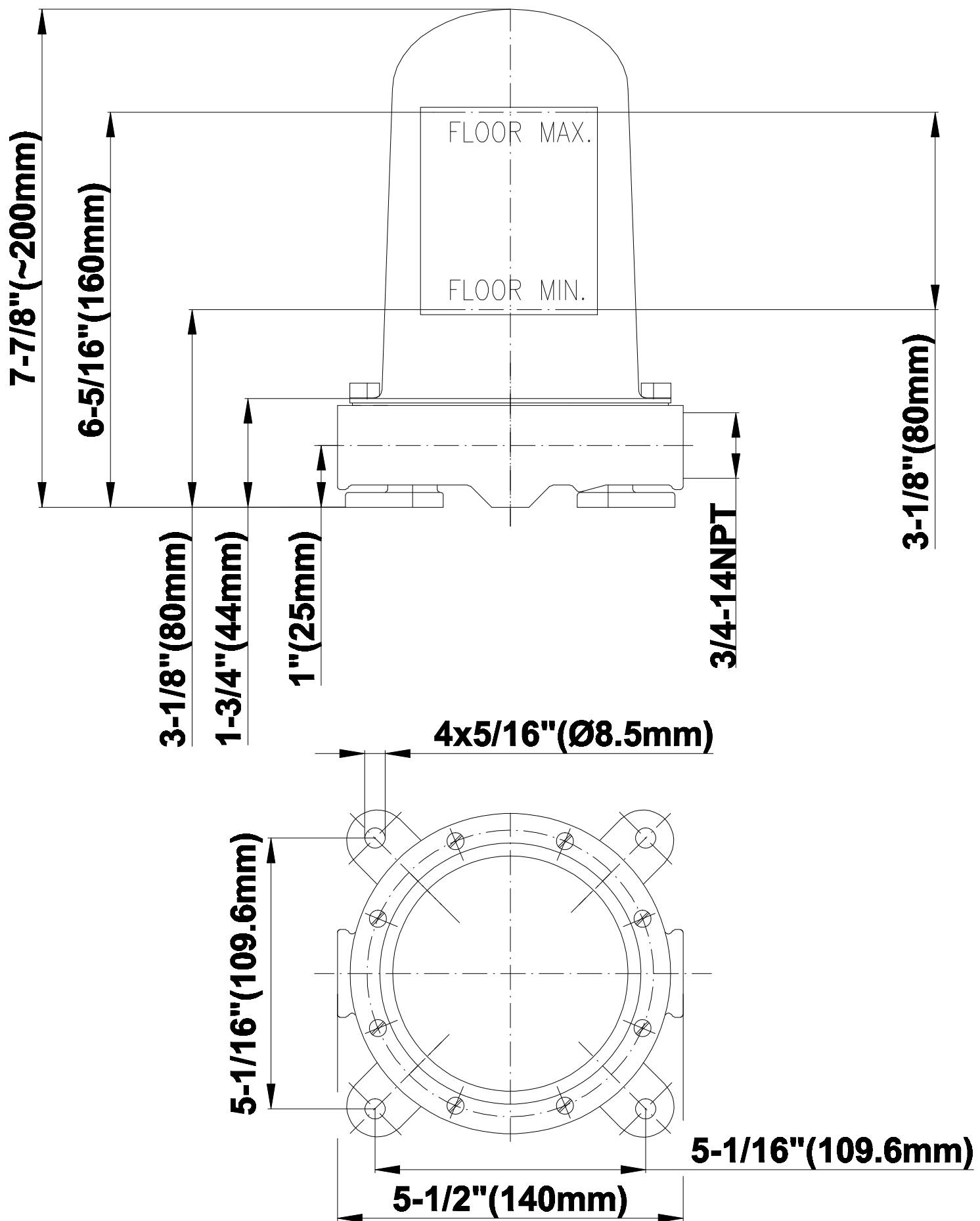

BATHROOM
Targa Floor-Mounted Tub Filler -
Spout Only
G-3652-T

GRAFF®



Information

- Floor-mount installation
- Aerated Flow Rate ~9 gpm @45 psi
- 9-7/8" spout reach
- 33-1/2" - 36-5/8" ~spout height
- Optional in-line pressure balancing valve

Finishes



24K Gold



24K Brushed
Gold



Architectural
Black™



Brushed
Nickel



Matte Black



Polished
Chrome



Polished
Nickel



Steelnox®
(Satin Nickel)



Architectural
White

G-3652

TARGA Series

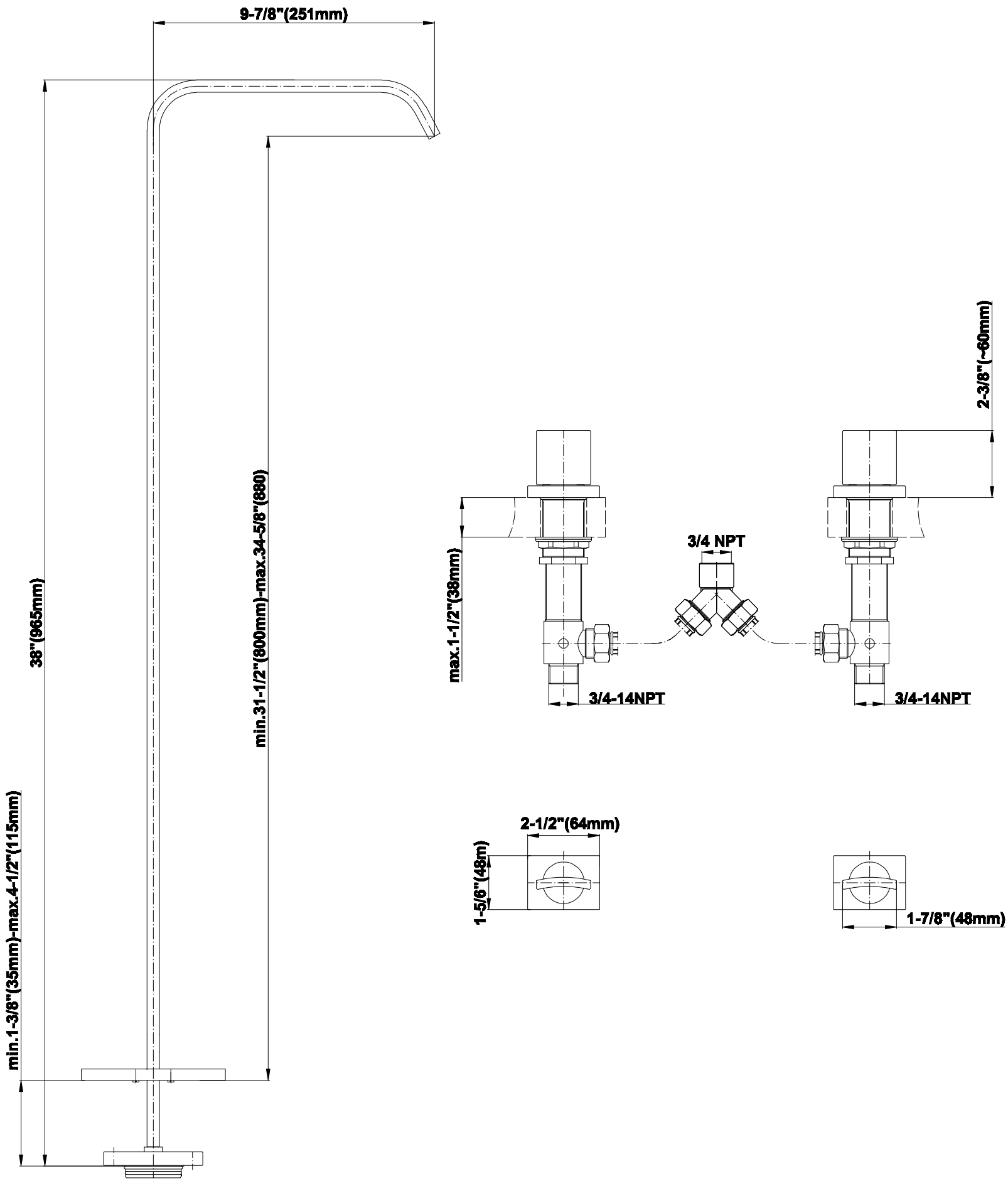

BATHROOM
Sade/Targa/Luna Wall-Mounted
Handshower & Diverter
G-6056

GRAFF®



Information

- Wall-mounted Handshower and Diverter Flow Rate 2.1 gpm @ 60 psi

Finishes



24K Gold



24K Brushed
Gold



Architectural
Black™



Brushed
Nickel



Matte Black



Polished
Chrome



Polished
Nickel



Steelnox®
(Satin Nickel)



Architectural
White

G-6056

SADE, TARGA, LUNA Series

