

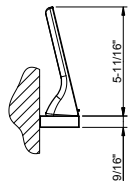

12V DC

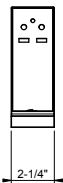
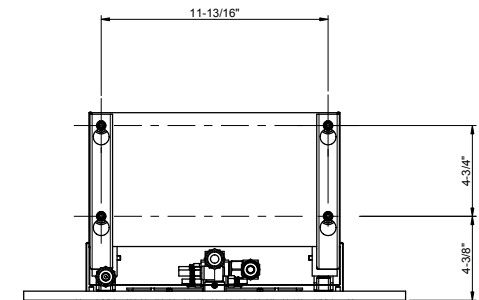
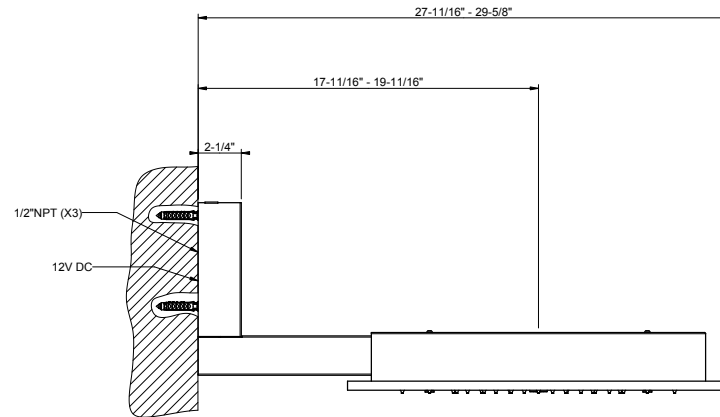
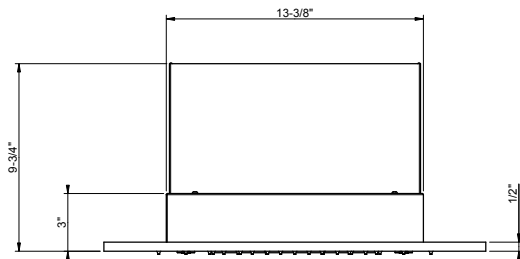
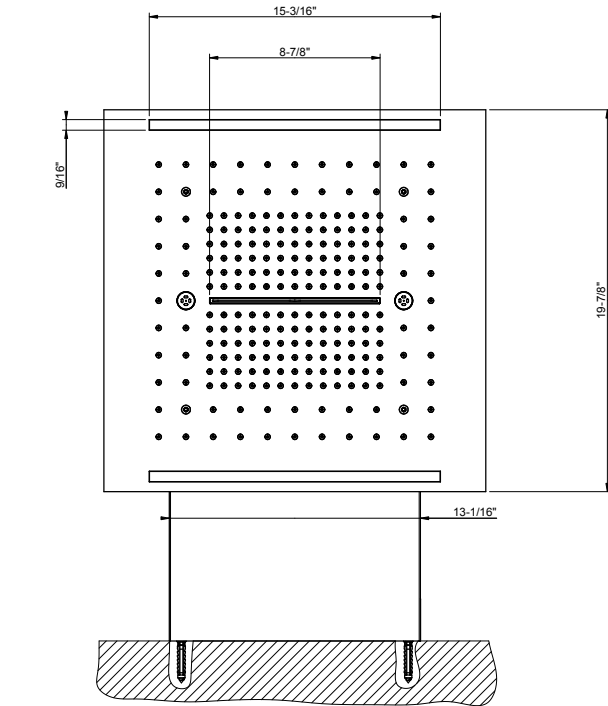

GESSI

MINIMAL COLOUR 57939

SOFFIONE DA PARETE 500X500 MULTIFUNZIONE COLOUR

Formato **A4**

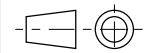

Dis.: GPF579390000G001

Gessi S.p.A. Parco Gessi, 13037 Serravalle Sesia (Vercelli) Italy Tel.0039 0163 454111 Fax.0039 0163 453150 www.gessi.com e-mail:gessi@gessi.it

This drawing by its legislation cannot be disclosed or reproduced without a written authorization released by GESSI S.p.A. - 2018 Copyright® GESSI S.p.A.