

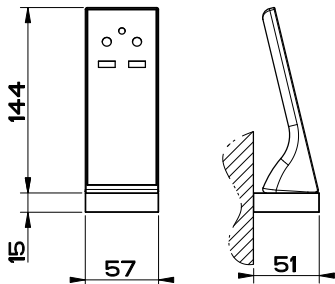

12V DC

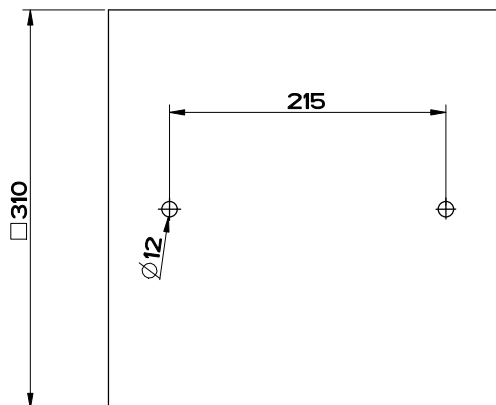
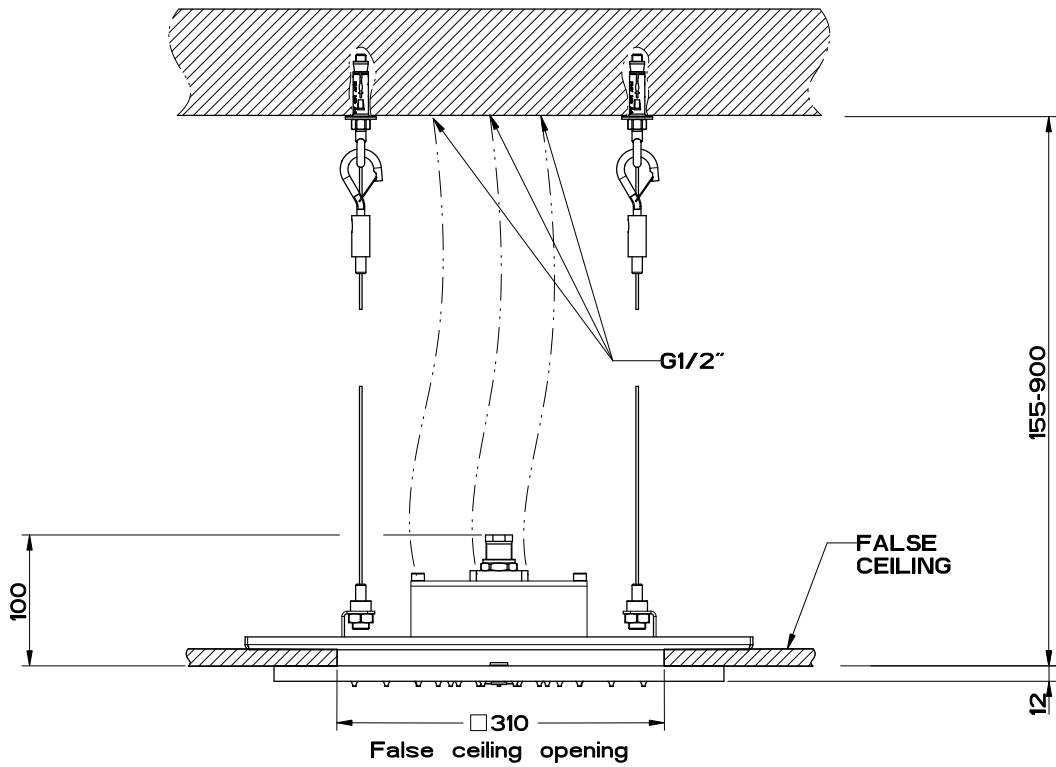
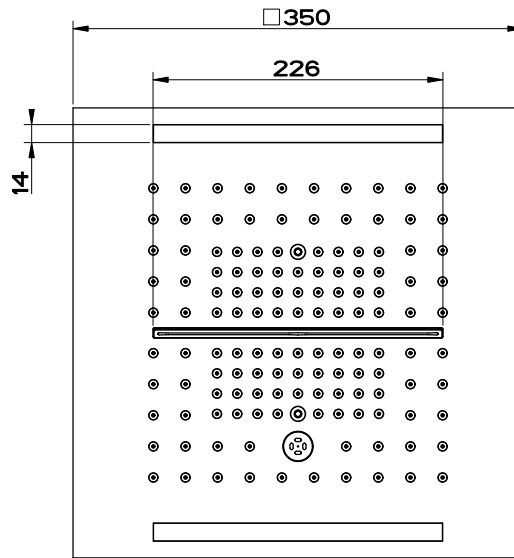

GESI

Gessi Sp.A. Parco Gessi, 13037 Serravalle Sesia (Vercelli) Italy

Tel.0039 0163 454111 Fax.0039 0163 453150

www.gessi.com e-mail: gessi@gessi.it gennaio 2016 copyright © GESSI S.p.A.

MINIMAL COLOUR 57827 + 57876

SOFFIONE 350X350 MULTIFUNZIONE COLOUR CON COVER

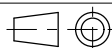

formato / size

A4

Rev.

0

codice cliente / client code