

Installation Instructions for your Microwave Oven

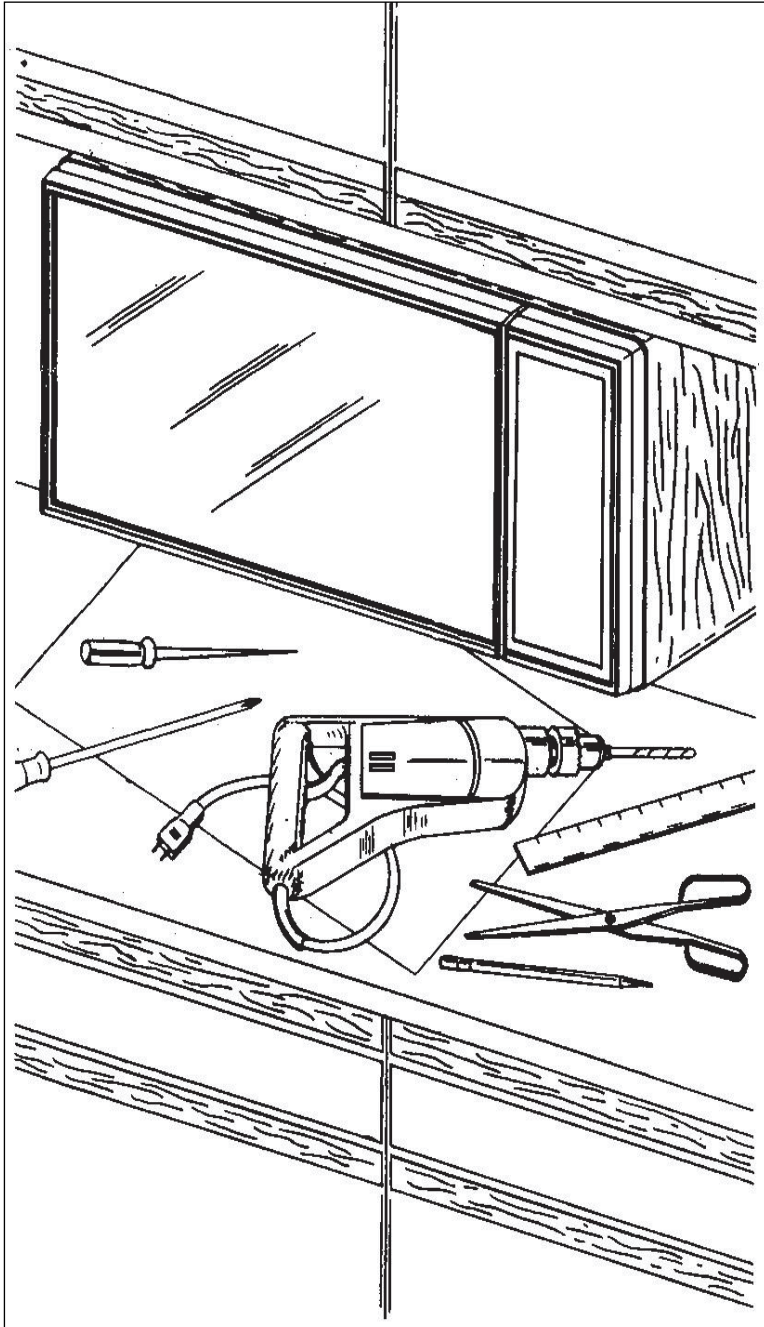

Installation Instructions
for Cabinet Mounting
Accessory Kit
Pub. No. 4-A019

Safety Instructions	p2
Tools you need	p2
Cabinet requirements	p3
Mounting your oven	p4

Save this book with your Use & Care Book

Important Safety Instructions

WARNING

This mounting Kit is designed for use with microwave ovens:

GE Spacemaker II™, Spacemaker III™ and Hotpoint CounterSaver® models.

Before attempting the installation of this kit, be sure to unplug the oven from wall receptacle.

Your oven is designed to be installed under properly constructed, good condition wood or metal cabinets that are sturdy enough to support the items you have in the cabinet, plus an additional 90 pounds from the cabinet bottom.

Empty the contents of your selected cabinet and the delicate items in adjoining cabinets.

(NOTE: When drilling the holes, the vibration could cause damage to fragile items such as crystal or china.)

Now, you must inspect your cabinets. If any of the following conditions exist, then it is your personal responsibility to test the cabinets or contact a qualified cabinet maker.

1. Separation of joints between the bottom shelf and the cabinet structure.
2. Splitting, cracking or other signs of deterioration.

3. Check the number of screws used to install your cabinets. If your cabinet is attached to the wall with only two screws at the top, then you must add two screws at the bottom to firmly secure your cabinets to the wall. When adding the screws, be sure that they enter wall studs with at least ½" (12 mm) penetration.

4. On wood cabinets, the bottom shelf must be at least ³⁄₁₆" (4 mm) thick masonite or plywood.

5. Be sure that the underside of the cabinet is at least 24" (61 cm) wide and 12" (30.5 cm) deep. If the cabinet is less than 12" (30.5 cm) deep, follow the cabinet mounting instructions (page 4) carefully if you desire to mount your oven under your cabinet.

To test your cabinets, place a 90lb. (40.8 kg) load, plus the equivalent weight of items normally stored on this shelf*, for a minimum of five minutes.

*You may consider using jugs of water, bricks or books to obtain the test load.

PLEASE NOTE: If your cabinet is properly constructed and suitably installed it will withstand this test without any damage: however, there is the possibility of damage should the cabinet be incapable of supporting the additional load.

Mabe Canada Inc. is NOT RESPONSIBLE FOR ANY DAMAGE OR OTHER CONSEQUENCES resulting from the performance of this test.

If you are unsure that your cabinets are suitable for this type of installation you may use the oven on your countertop.

Installation Instructions

Tools

The following tools are needed for installation of your unit:

- Drill and ¼" drill bit
- Phillips and flat blade screwdrivers
- Nail or center punch
- Pencil and ruler
- Scissors
- Hammer

Two Mounting Methods

There are two mounting methods described in this booklet that can be used.

1. Countertop Method

You can use this method if you decide not to cabinet mount your oven.

To use your oven as a countertop model, simply position the oven on the desired counter and plug the electrical cord into the three prong (grounded) wall receptacle. (Fig. 1)

2. Cabinet Mounting Method

This method is for mounting your oven under a cabinet (Fig. 2, 3, 4, 5, 6) and uses the template, in-cabinet mounting straps, rear brackets (if required) and one set of screws. Before using this method, the 4 plastic plug buttons on the top of the oven must be removed. This can be done by placing a thin flat blade screwdriver between the plug button and the oven top and raising gently, taking care to avoid scratching the oven top.

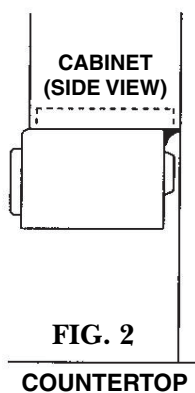
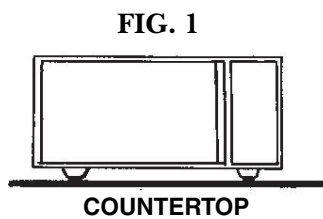

OVEN MAY BE MOUNTED TO CABINETS WITH OR WITHOUT A FRONT RAIL.

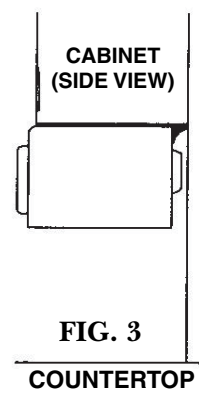

Selecting Your Mounting Location

When selecting your mounting location for your unit, remember the following:

- For mounting and dismantling ease, allow adequate space between the oven and an adjacent wall or appliance. Installation will be easier if adequate space is allowed for hand clearance. (Fig. 4)

FIG. 4

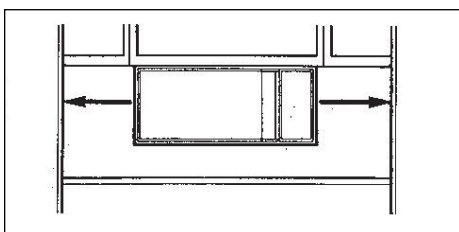

- Installation will be easier if the oven can be mounted under one cabinet rather than running under two cabinets.

- DO NOT BLOCK VENTS AND OPENINGS.
- DO NOT INSTALL THE OVEN OVER COOKING OR OTHER HEATING APPLIANCES SUCH AS A RANGE OR TOASTER OVEN. THIS MAY CAUSE DAMAGE TO YOUR OVEN.

- A flush installation, as shown in Fig. 5, depends on microwave oven and cabinet depth. The microwave oven may extend beyond the front surface or the cabinet as shown in Fig. 2 and Fig. 3.

FIG. 5

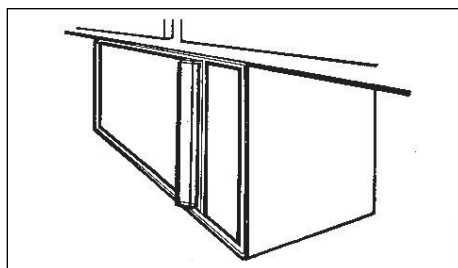

- Be sure that a three prong (grounded) wall receptacle is within reach of the electrical cord when properly draped. The wall receptacle cannot be located behind the oven when installed, because the power cord plug may hit the back of the oven and prevent proper installation. (Fig. 6)

FIG. 6

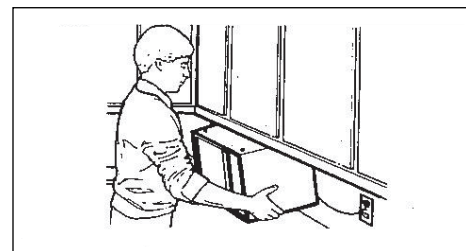

Cabinet Mounting Method

Preparations

Select the correct template (see template/rear bracket reference sheet.) Open the template and detach both segments along the dashed lines with scissors. You should have two separate pieces. (Fig. 7)

- Template 1
- Template 2. Make sure you use the template properly depending whether you drill holes from the inside or bottom side of the cabinet. (Fig. 7)

FIG. 7

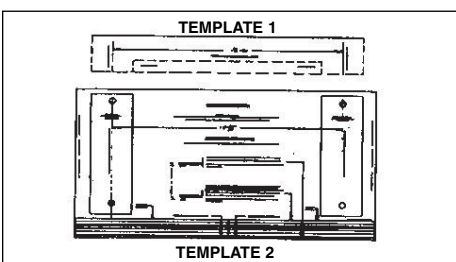

Instructions for Drilling

You can drill from inside of the cabinet if you have adequate space and your shelves are removable.

If you cannot drill from the inside, go to Instructions for Drilling from Bottom.

1. If your cabinet is less than 12" (30.5 cm) deep, cut off the front edge of Template 2 the amount by which the cabinet depth is less than 12" (30.5 cm), using the template cut lines as a guide. Place Template 2 inside cabinet. Cut around door jam and if necessary, corners to make template fit. (The front edge of template must be even with the front edge of the cabinet). Place Template 2 in cabinet.

Note: For cabinets with a recessed shelf you must measure the thickness of the front rail and cut the amount off the front edge of Template 2 using the template cut lines as a guide. This will allow Template 2 to lay flat on the shelf.

2. If you have a partition you must do the following:

- Cut Template 2 into two pieces to fit each side of partition.
- Position one piece of Template 2 inside the cabinet making sure that the front edge is even with the front edge of the cabinet.
- Position Template 1 on front of the cabinet so that the arrow is aligned with the hole center line on Template 2. (Fig. 8)

FIG. 8

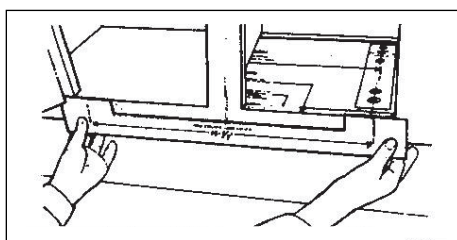

- Position remaining piece of Template 2 inside cabinet and align the hole center lines with arrow on Template 1 so that the distance from right hole center to left hole center measures the distance indicated on the template. (You will have to cut excess paper from the middle of Template 2 to make it lay flat.)

- Position the remaining piece of Template 2 inside cabinet. (Fig. 9)

FIG. 9

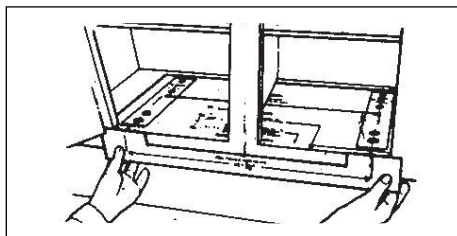

- Check again to make sure that the hole center lines on Template 2 are straight and that the distance from right to left drilling holes measures the distance indicated on the template.

3. Go to Drilling the Mounting Holes.

Instructions for Drilling From Bottom

1. If you have a front rail, measure the thickness and cut that amount off the front edge of Template 2 using the template cut lines as a guide.

2. Place cut edge of Template 2 against the back side of the front rail and position if flat against the bottom side of the cabinet.

Note: On some cabinets a small bracket or glue block is used between the overhang and the underside of the cabinet bottom. If this is true of your cabinets, cut Template 2 to fit around the bracket of glue block so that it will be flat on the cabinet bottom when attached. (Fig. 10)

FIG. 10

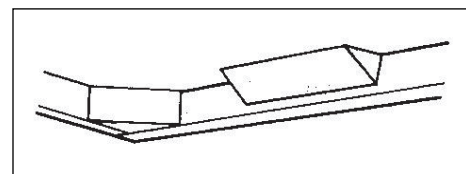

3. If you have a partition you must do the following:

- Cut Template 2 into two pieces to fit on each side of partition
- Position one piece of Template 2 under the cabinet. (The cut line along the front edge of Template 2 must be placed against the back of the front rail.)

Cabinet Mounting Method (cont.)

- Attach Template 1 to rear of cabinet and align arrow with hole center line on Template 2. (Fig. 11)

FIG. 11

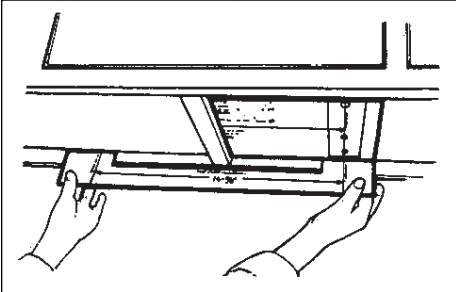

- Position remaining piece of Template 2 under the cabinet and align the hole center lines with arrows on Template 1 so that the distance from right hole center to left hole center measure the distance indicated on the template. (You may have to cut excess paper from the middle of template to make it lay flat.)
- Position Template 2. (The cut line along the front edge of template must be placed against the back of the front rail. (Fig. 12)

FIG. 12

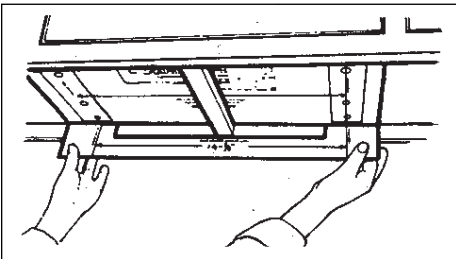

Drilling the Mounting Holes

While drilling, it is recommended that safety glasses be worn to prevent possible eye damage from cabinet shavings.

1. Use a center punch or nail to make an indentation for centering the drill bit.

2. Drill through Template 2 at the four black drilling holes indicated on the template. (Drill should be held straight to ensure proper alignment of bolts.)
3. After drilling the four holes, remove the template and clean the drilled holes.

Important

Selecting Your Mounting Bolts

1. You should have three sets of bolts of varying lengths in the installation package. Select on bolt of each size.
2. Hold each bolt against the cabinet front rail. **Pick the bolt that extends beyond top of the bottom shelf by $\frac{3}{16}$ " (4 mm) to $\frac{3}{4}$ " (19 mm).** This will be the bolt length needed for your cabinets. (Fig. 13)

FIG. 13

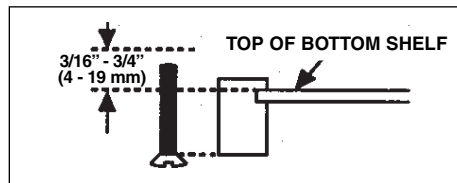

Note: It is important to pick the correct bolt length needed for your cabinets. **If the bolt is too short, it won't reach the oven. If the bolt is too long, it will not permit oven to be drawn up to cabinet snugly and might damage the microwave oven.**

3. From inside the cabinet, insert the bolts through mounting straps and then into the drilled holes.

Attaching the Rear Brackets

For models with no rear brackets skip to Mounting the Oven.

1. Remove the two top case screws on the back of the oven. (See Template/Rear Bracket Reference Guide.)
2. Select the two rear brackets for the model you have and then secure to the oven back with the two top case screws. Make sure that the flat top surface of the rear brackets are level and flush with the top surface of the oven case. (Fig. 14)

FIG. 14

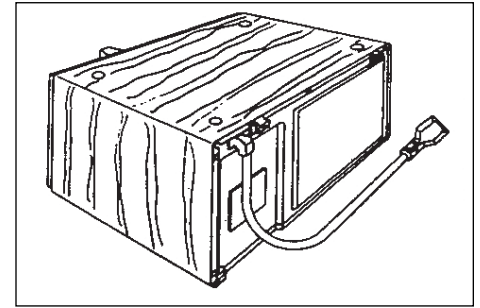

Mounting the Oven

To aid installation, we suggest that you use some solid support such as books to hold the oven while you are securing it with the mounting bolts. (Fig. 15)

FIG. 15

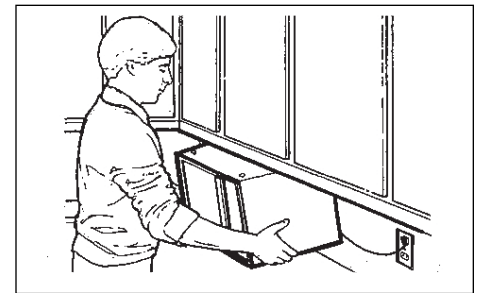

Make sure that whatever you use is stacked or cut as close as possible to the height needed for oven to reach the cabinet bottom.

1. Place the oven on the support and move into position. Lift oven, aligning the mounting holes on the oven with the bolts. Do not grip the door handle to help lift the oven.
2. Insert bolts into mounting holes on the oven. Tighten the bolts to secure oven to the bottom of the cabinet. (Alternate between bolts so that oven is drawn up evenly.)
3. Once oven is securely in place, plug power cord into three prong (grounded) wall receptacle.

