

Shower only Trim Kit / Tub & Shower Trim Kit

SPECIFICATIONS

Features/Benefits

- 2.0 gpm (7.6 L/min) Maximum Flow Rate @ 80 psi
- Includes Treysta™ Pressure Balance Ceramic Disc Cartridge
- Requires Treysta™ Rough-In Valve, G00GS500 Series (Horizontal Inputs) or G00GS520 Series (Vertical Inputs)
- Includes Single-Function Viper™ Showerhead, G0049107
- Diverter on Tub Spout (Only for Tub & Shower Trim Kits Products)
- Accommodates Standard, Back-to-Back, and Thin Wall Installations
- 6" Metal Shower Arm



Available Color/Finishes

Chrome

Please see gerber.com or current price list for available finishes. Finish is defined by additional suffix.

Standards & Certifications



(Lever Handle)

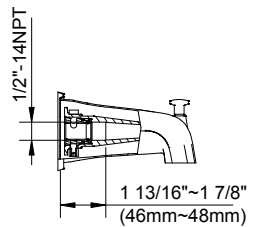
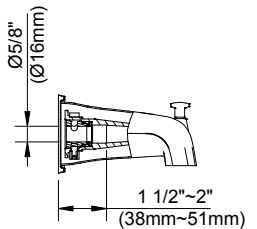
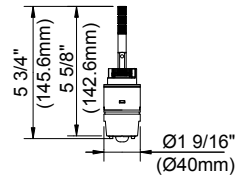
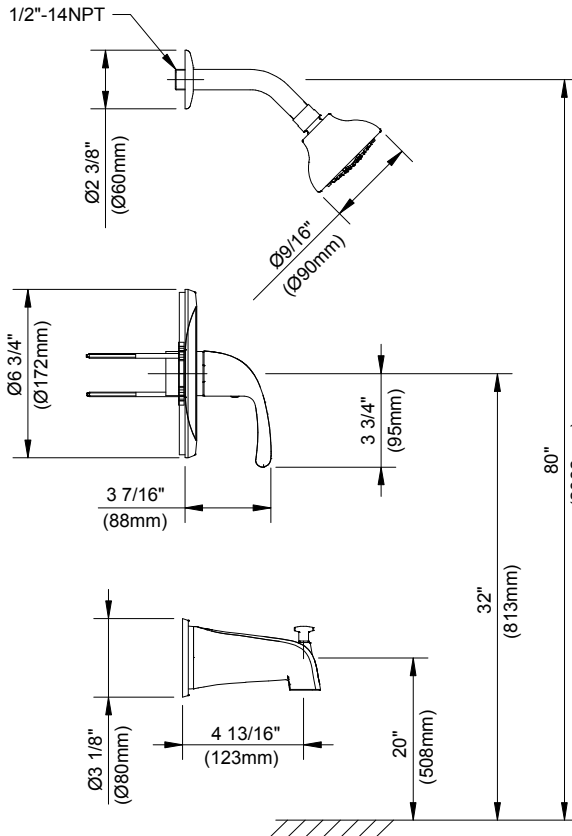
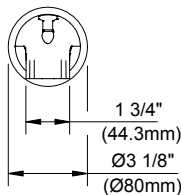
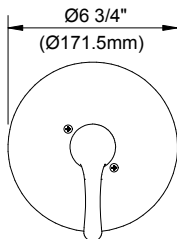
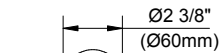

Submittal Information:

Name: _____
 Location: _____

Contractor: _____
 Contact #: _____