

SPECIFICATIONS



Features/Benefits



- 4 5/16" (110mm) Spout Height, 6 5/8" (168mm) Spout Reach
- Metal Spout
- Requires Roman Tub Rough-In Valve, D215000BT, Sold Separately
- Optional Personal Spray and Personal Spray Rough-In Sold Separately
- 3-Hole Slip Spout Mounting

Available Color/Finishes

Color tiles intended for reference only.

Color	Code	Description
		Chrome
	BN	Brushed Nickel
	BS	Satin Black

Standards & Certifications

ASME A112.18.1/CSA B125.1

ADA

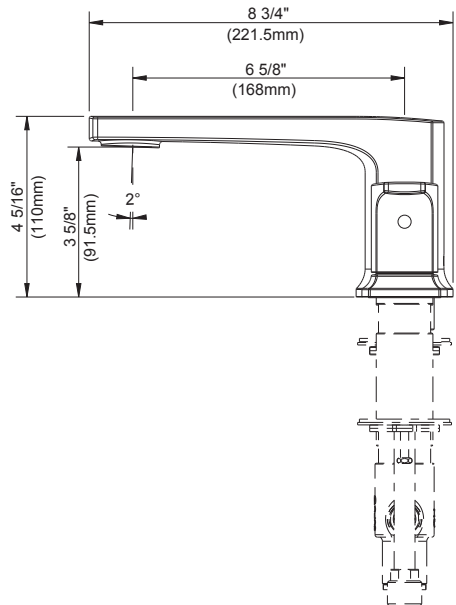
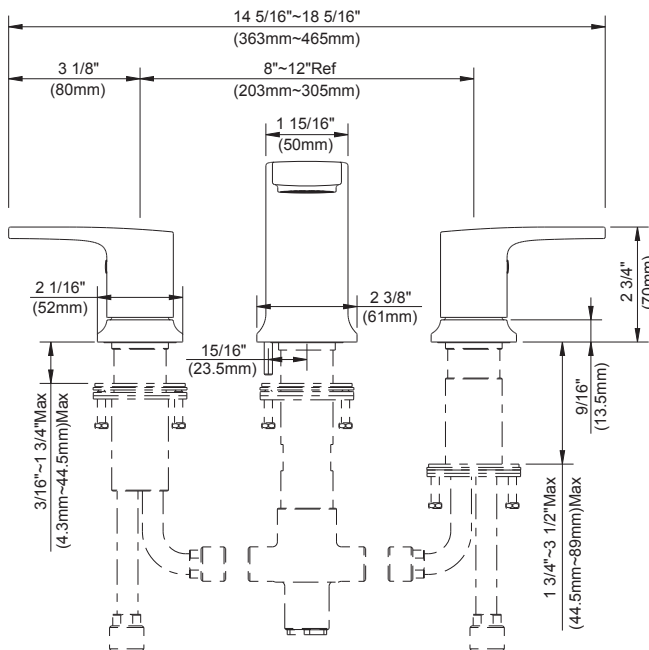

Submittal Information:

Name: _____
 Location: _____

Contractor: _____
 Contact #: _____

CARACTÉRISTIQUES



Caractéristiques et avantages



- Bec de 4 5/16 po (110mm) de hauteur, portée de 6 5/8 po (168mm)
- Bec en métal
- Soupape de plomberie brute pour baignoire romaine nécessaire, vendue séparément (D215000BT)
- Douchette personnelle en option et plomberie brute de la douchette vendues séparément
- Montage à 3 trous du bec à assemblage coulissant

Couleurs/finis offerts

Les carrés de couleur ne sont fournis qu'à titre de référence seulement.

Couleur	Code	Description
		Chrome
	BN	Nickel Brossé
	BS	Noir Satiné

Normes et certifications

ASME A112.18.1/CSA B125.1
ADA

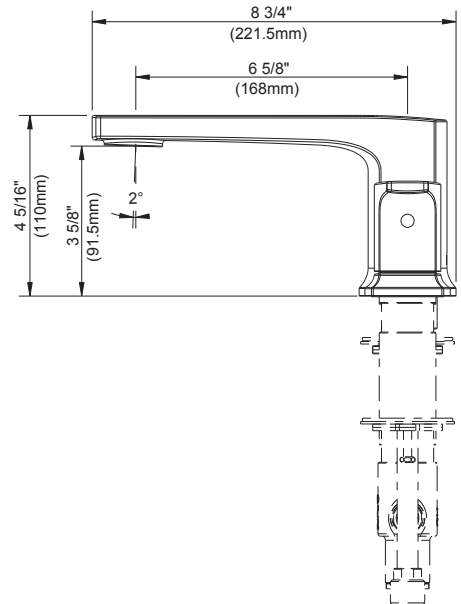
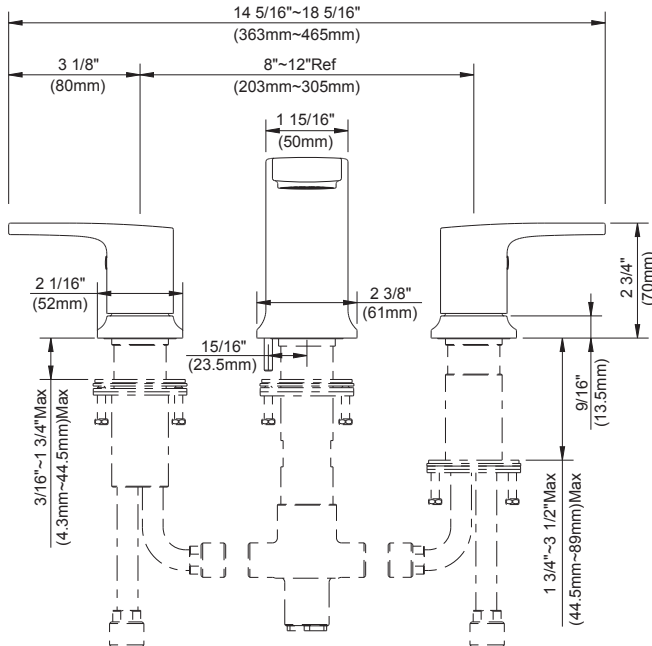

Renseignements pour la soumission :

Nom : _____
Emplacement : _____

Entrepreneur : _____
Numéro de téléphone : _____

Kit de grifería para bañera romana de dos manijas

ESPECIFICACIONES

Características/Beneficios



- Altura del caño de 4 5/16" (110mm); alcance del caño de 6 5/8" (168mm)
- Caño de metal
- Requiere la válvula de empalme de la bañera romana (D215000BT), se vende por separado
- Los accesorios opcionales como el rociador personal y su empalme se venden por separado
- Montaje de caño deslizante de 3 orificios

Colores/Acabados disponibles

Estándares y certificación

Los cuadros de color son solo de referencia.

ASME A112.18.1/CSA B125.1

ADA

Color	Código	Descripción
		Cromo
	BN	Níquel Cepillado
	BS	Negro Satinado

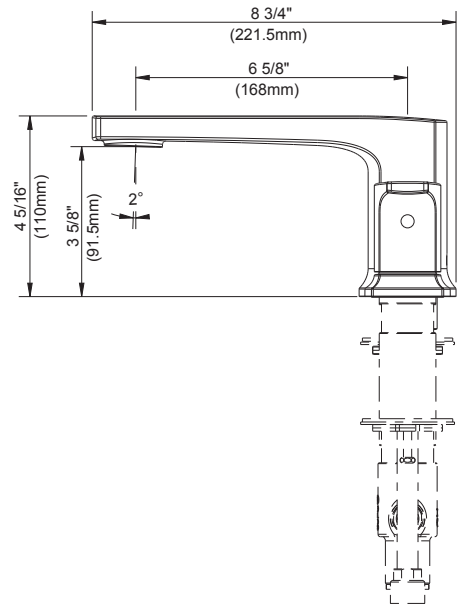
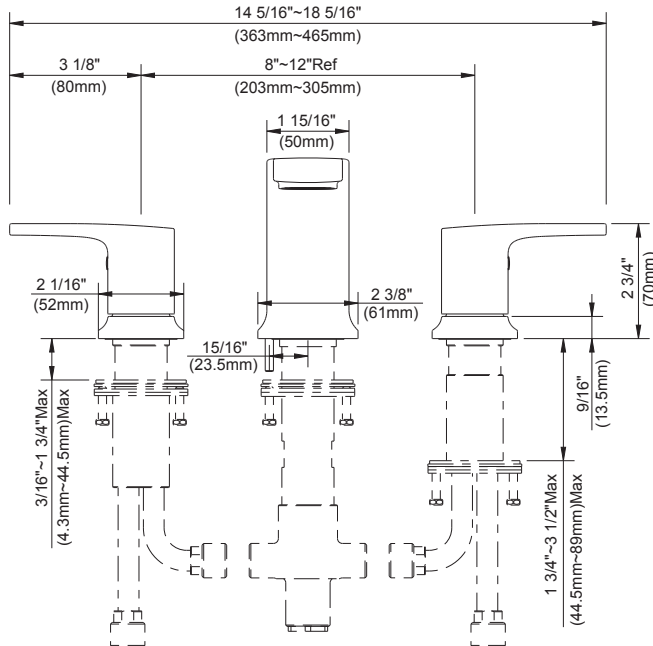

Información a presentar:

Nombre: _____
 Ubicación: _____

Contratista: _____
 N.º de contacto: _____