

Peak PKX11021 Stainless Steel | 122.0074.956

FAMILY : Sinks | SERIE : Peak | MODEL : PKX11021 | FINISH : Stainless Steel | INSTALLATION TYPE : Undermount | STYLE : Contemporary

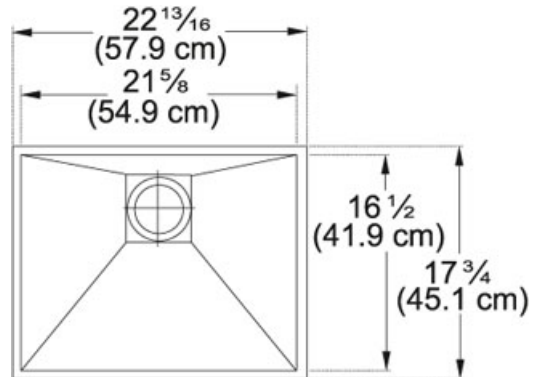

TECHNICAL DATA

Minimum Cabinet Size	24"
Drain Opening	3 1/2"
Length overall	23 13/16"
Width overall	17 3/4"
Length of large bowl	21 5/8"
Width of large bowl	16 1/2"
Depth of large bowl	9 7/8"
Number of Bowls	1
Cutout Length	21 5/8"
Cutout Width	16 9/16"
Type of Material	16-GA-STAINLESS-STEEL
Cut-Out Template	Yes
Installation Clips	Yes
Franke Integral Ledge	BUILT-IN
Where to buy	Showroom
Where to buy	Showroom

Peak PKX11021 Stainless Steel | 122.0074.956

FAMILY : Sinks | SERIE : Peak | MODEL : PKX11021 | FINISH : Stainless Steel | INSTALLATION TYPE : Undermount | STYLE : Contemporary

RELATED PARTS



112.0074.976



122.0074.951



122.0074.944



122.0074.938



122.0192.590



122.0074.954

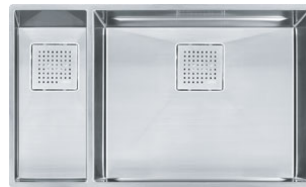

122.0074.965



122.0080.011

RECOMMENDED



115.0298.341



119.0355.521



119.0068.283



134.0297.202



133.0171.120

119.0066.616