

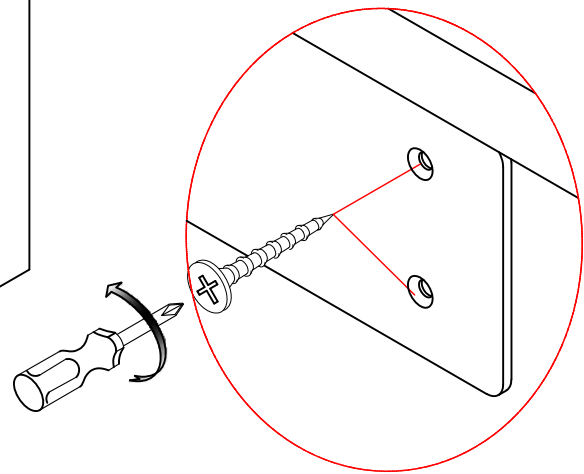

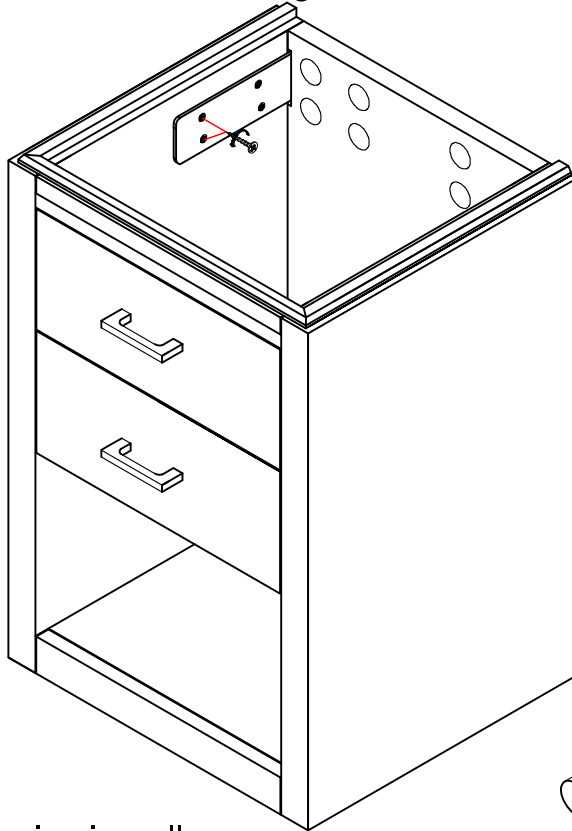

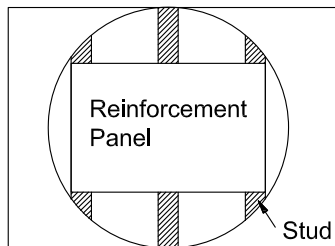

1517-WV1816
Step 1: Detach mounting bracket from vanity

Cut opening in wall

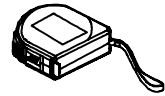
Reinforcement Panel

* Large enough to cover 2 studs

* Not provided by manufacturer

Parts Included				Tools And Materials		
1		50x50x50x3mm	2pcs	   Screwdriver Tape measure Pencil		
2		Ø8x38mm	10pcs			
3		Ø8x19mm	2pcs			
4		Ø10x28mm	10pcs			

Fairmont Designs highly recommends that you seek a professional installation specialist if you are unsure of installation. Please note: Fairmont Designs is not responsible for any installation error, damages or injuries, actual or consequential resulting from possible printing error in instruction

1517-WV1816

Step 2: Mounting bracket must be attached to reinforcement panel.

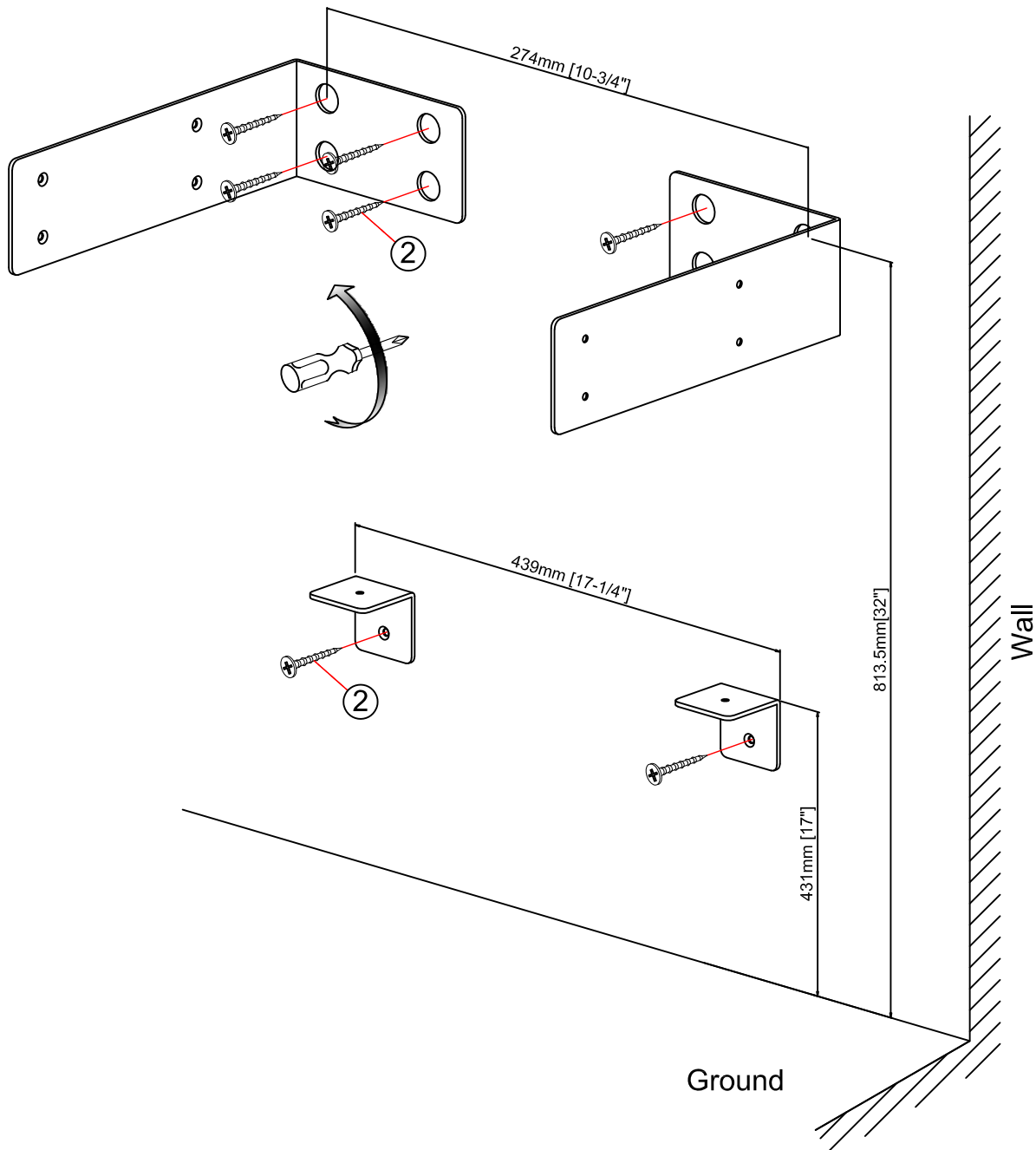

Fairmont Designs highly recommends that you seek a professional installation specialist if you are unsure of installation. Please note: Fairmont Designs is not responsible for any installation error, damages or injuries, actual or consequential resulting from possible printing error in instruction

1517-WV1816

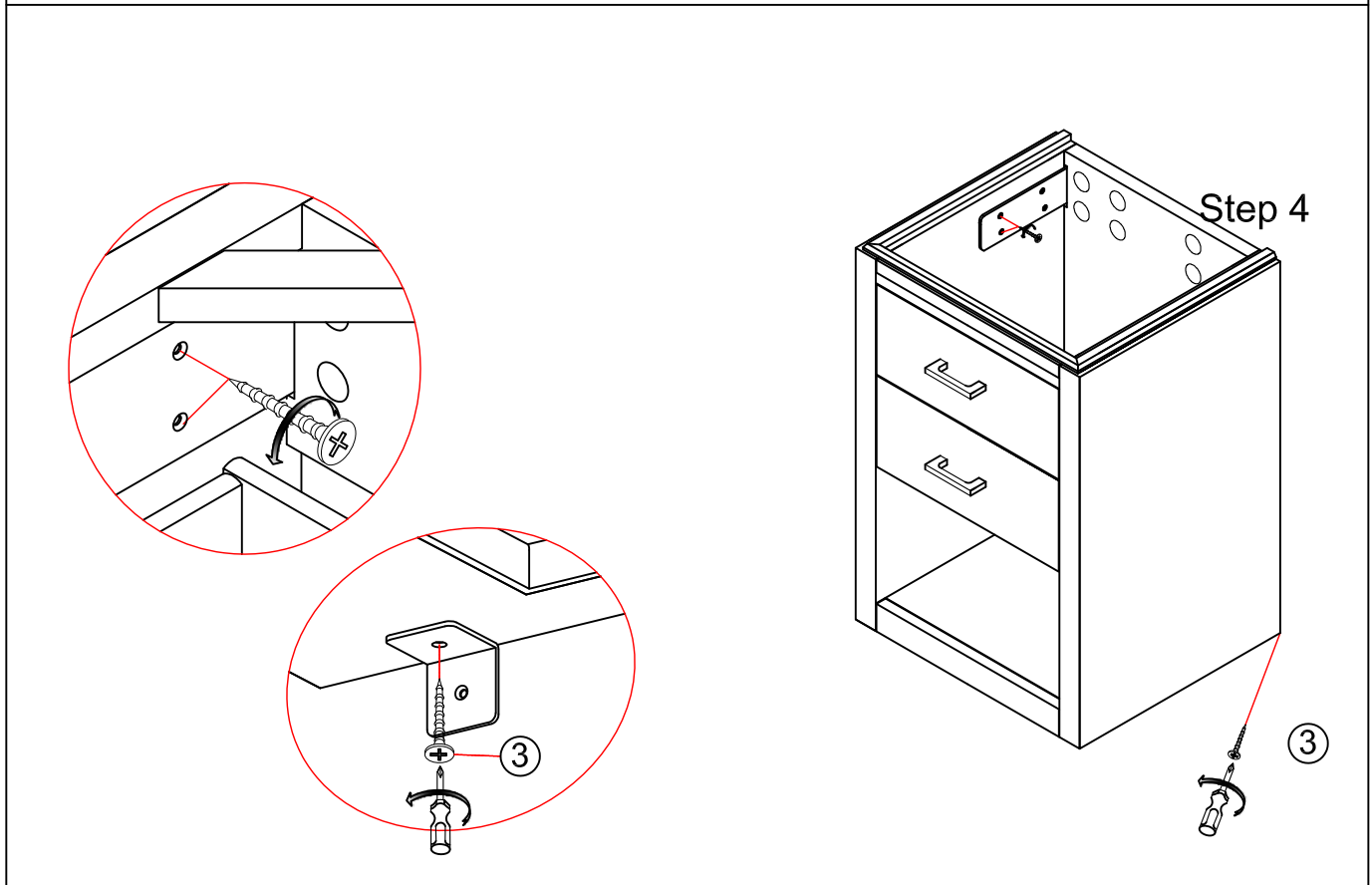
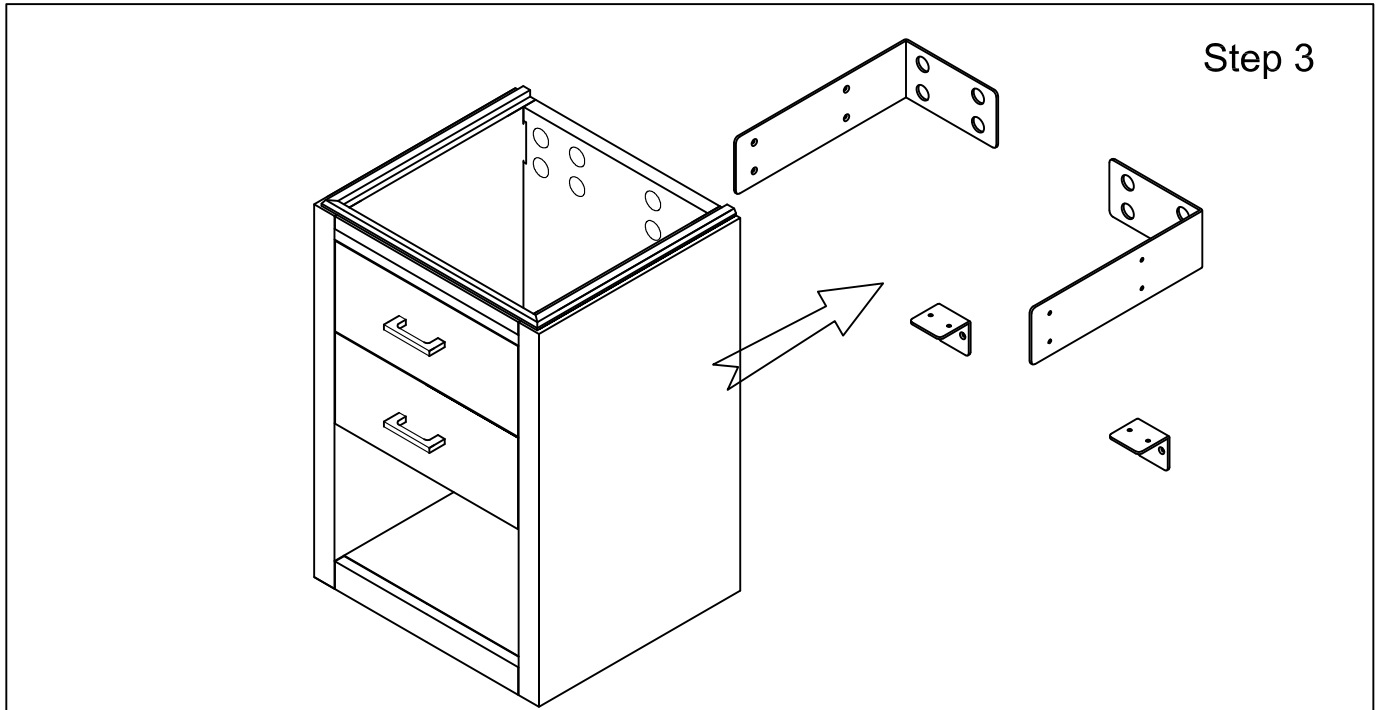

Fairmont Designs highly recommends that you seek a professional installation specialist if you are unsure of installation. Please note: Fairmont Designs is not responsible for any installation error, damages or injuries, actual or consequential resulting from possible printing error in instruction