

PRODUCT SPECIFICATIONS

Elkay Stainless Steel 48" x 24" x 36" 16 Gauge Flat Top Work Table with Stainless Steel Legs and Undershef. Sink is manufactured from 16 gauge Stainless Steel with a #4 Finish .

Material:	Stainless Steel
Finish:	#4 Finish
Gauge:	16
Weight Without Packaging:	82
Number of Bowls:	0
Sink Dimensions:	48" x 24" x 36"
Leg Type:	Stainless Steel

Special Note: 18 Gauge Stainless Steel Undershef



Included with Product: Undershef, stainless steel legs, and adjustable bullet feet.

AMERICAN PRIDE. A LIFETIME TRADITION.
Like your family, the Elkay family has values and traditions that endure. For almost a century, Elkay has been a family-owned and operated company, providing thousands of jobs that support our families and communities.

Product Compliance: NSF 2

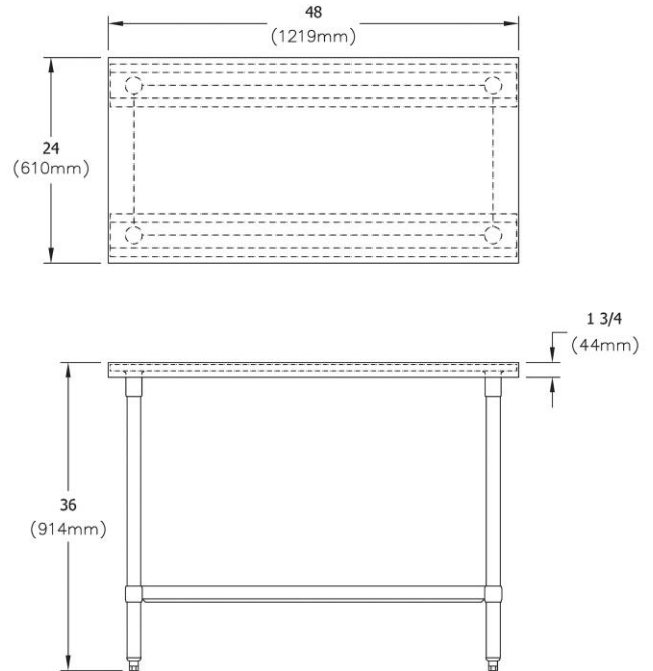

PART: _____ QTY: _____
 PROJECT: _____
 CONTACT: _____
 DATE: _____
 NOTES: _____
 APPROVAL: _____

In keeping with our policy of continuing product improvement, Elkay reserves the right to change product specifications without notice. Please visit elkay.com for the most current version of Elkay product specification sheets. This specification describes an Elkay product with design, quality, and functional benefits to the user. When making a comparison of other producers' offerings, be certain these features are not overlooked.