

PRODUCT SPECIFICATIONS

Elkay CuVerro Antimicrobial Copper 17" x 22" x 5", Single Bowl Drop-in ADA Sink. Sink is formed from 18 gauge CuVerro[®] Antimicrobial Copper that combines beauty and performance to be the only touch surface material registered by the U.S. Environmental Protection Agency (EPA) to continuously kill more than 99.9% of bacteria within two hours. Sink has Rear Center drain placement, and Bottom only pads.

Installation Type:	Drop-in
Material:	CuVerro Antimicrobial Copper
Finish:	Lustrous Satin
Gauge:	18
Sound Deadening:	Bottom only pads
Number of Bowls:	1
Sink Dimensions:	17" x 22" x 5"
Bowl 1 Dimensions:	13-1/2" x 16" x 4-7/8"
Drain Size:	3-1/2" (89mm)
Drain Location:	Rear Center
Minimum Cabinet Size:	21"
Mounting Hardware:	Part # 64090012 included for countertops up to 3/4" (19mm) thick
Cutout Template #:	1000001289

Template is available for download at [elkay.com](#)

Cutout Dimensions for Top Mount Installation:

16-3/8" x 21-3/8" (416mm x 543mm) with 1-1/2" (38mm) corner radius

Hole Drilling Configurations:

1-1/2" (38mm) Diameter Faucet Holes on 4" (102mm) Centers

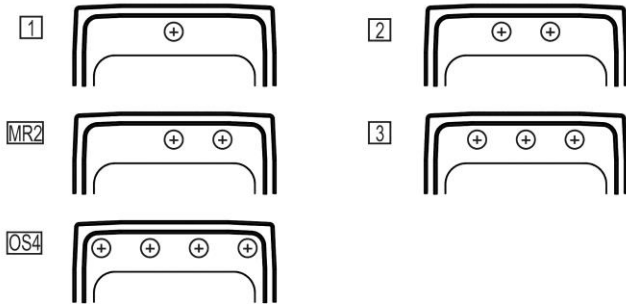

AMERICAN PRIDE. A LIFETIME TRADITION.
Like your family, the Elkay family has values and traditions that endure. For almost a century, Elkay has been a family-owned and operated company, providing thousands of jobs that support our families and communities.



Product Compliance: ADA & ICC A117.1
BUY AMERICAN ACT
CSA B45.12/IAPMO Z402



Sinks are listed by IAPMO[®] as meeting the applicable requirements of the Uniform Plumbing Code[®], International Plumbing Code[®], and National Plumbing Code of Canada.



Complies with ADA & ICC A117.1 accessibility requirements when installed according to the requirements outlined in these standards.

- [Clean and Care Manual \(PDF\)](#)
- [Clean and Care Manual \(PDF\)](#)
- [Installation Instructions \(PDF\)](#)
- [Limited Lifetime Warranty \(PDF\)](#)

Similar models are available with: additional ADA depths

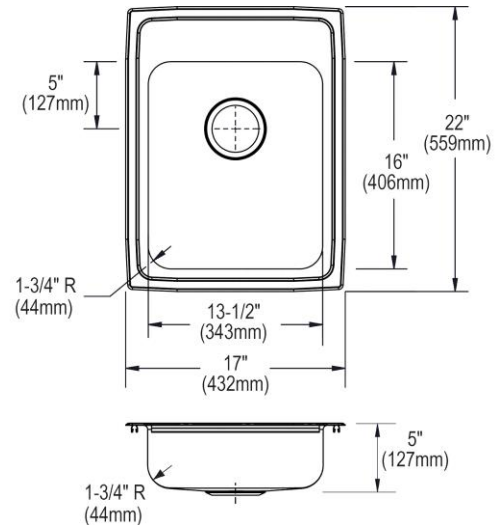

PART: _____ QTY: _____
 PROJECT: _____
 CONTACT: _____
 DATE: _____
 NOTES: _____
 APPROVAL: _____

In keeping with our policy of continuing product improvement, Elkay reserves the right to change product specifications without notice. Please visit [elkay.com](#) for the most current version of Elkay product specification sheets. This specification describes an Elkay product with design, quality, and functional benefits to the user. When making a comparison of other producers' offerings, be certain these features are not overlooked.

Installation Profile:

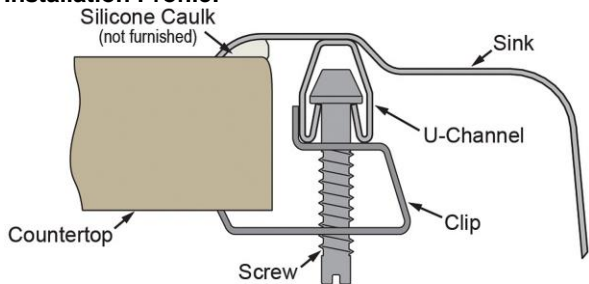

OPTIONAL ACCESSORIES

Drain:	LKVR18-CU
Hardware:	LK364, LK463

In keeping with our policy of continuing product improvement, Elkay reserves the right to change product specifications without notice. Please visit elkay.com for the most current version of Elkay product specification sheets. This specification describes an Elkay product with design, quality, and functional benefits to the user. When making a comparison of other producers' offerings, be certain these features are not overlooked.