

**PRODUCT SPECIFICATIONS**

Elkay 4" Centerset with Exposed Deck Laminar Flow Faucet with 8" Gooseneck Spout 2" Lever Handles Chrome. Faucet has a flow rate of 1.5 GPM, and is made of Chrome Plated Brass material, with a Quarter Turn Ceramic Disc valve. Faucet requires 2 faucet holes.

<b>Mounting Type:</b>	Deck Mount
<b>Special Features:</b>	Low Flow Solid Brass Construction Spout swing restriction pin
<b>Finish:</b>	Chrome (CR)
<b>Handle Type:</b>	2" Lever Handle
<b>Deck Clearance:</b>	8-1/2"
<b>Spout Reach:</b>	8"
<b>Spout Height:</b>	14-1/8"
<b>Hole Drillings:</b>	2
<b>Material:</b>	Chrome Plated Brass
<b>Valve Type:</b>	Quarter Turn Ceramic Disc
<b>Valve Connection:</b>	1/2" NPSM Male
<b>Flow Rate:</b>	1.5 GPM
<b>Faucet Hole Spread:</b>	4
<b>Spout Type:</b>	Gooseneck



**AMERICAN PRIDE. A LIFETIME TRADITION.**  
Like your family, the Elkay family has values and traditions that endure. For almost a century, Elkay has been a family-owned and operated company, providing thousands of jobs that support our families and communities.

**Product Compliance:** ADA & ICC A117.1  
ASME A112.18.1/CSA B125.1  
NSF 61  
NSF 372 (lead free)



Complies with ADA & ICC A117.1 accessibility requirements when installed according to the requirements outlined in these standards.

[Clean and Care Manual \(PDF\)](#)  
[Installation Instructions \(PDF\)](#)  
[Limited Warranty \(PDF\)](#)

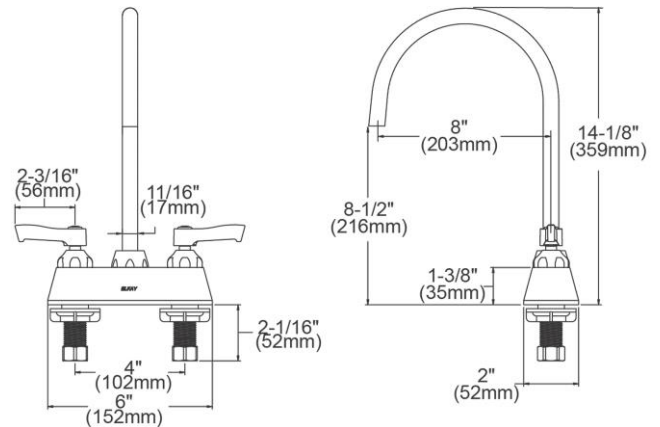

PART: \_\_\_\_\_ QTY: \_\_\_\_\_  
PROJECT: \_\_\_\_\_  
CONTACT: \_\_\_\_\_  
DATE: \_\_\_\_\_  
NOTES: \_\_\_\_\_  
APPROVAL: \_\_\_\_\_

*In keeping with our policy of continuing product improvement, Elkay reserves the right to change product specifications without notice. Please visit [elkay.com](http://elkay.com) for the most current version of Elkay product specification sheets. This specification describes an Elkay product with design, quality, and functional benefits to the user. When making a comparison of other producers' offerings, be certain these features are not overlooked.*

ITEM	IND. PART	DESCRIPTION
1	1000002619	Spout
2	45918C	Handle, 2"
3	45923C	Right Cold Cartridge
4	45924C	Left Hot Cartridge
5	45917C	Body
6	LK734	2.2 GPM VR Aerator

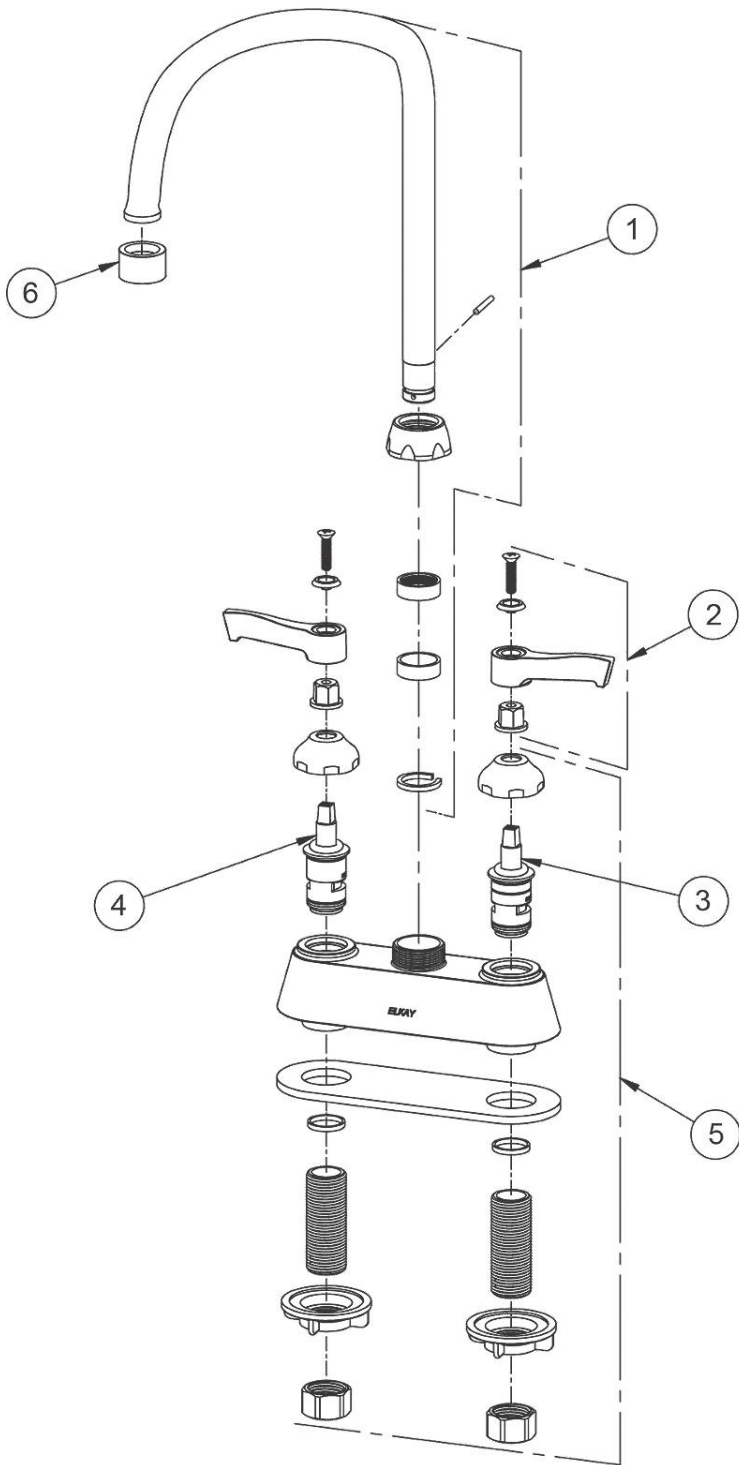

*In keeping with our policy of continuing product improvement, Elkay reserves the right to change product specifications without notice. Please visit [elkay.com](http://elkay.com) for the most current version of Elkay product specification sheets. This specification describes an Elkay product with design, quality, and functional benefits to the user. When making a comparison of other producers' offerings, be certain these features are not overlooked.*