

PRODUCT SPECIFICATIONS

Dayton Stainless Steel 15" x 15" x 5-3/16", Single Bowl Drop-in Bar Sink. Sink is manufactured from 23 gauge 300 series Stainless Steel with a Satin finish, Center drain placement, and Bottom only pads.

Installation Type:	Drop-in
Material:	300 series Stainless Steel
Finish:	Satin
Gauge:	23
Sound Deadening:	Bottom only pads
Number of Bowls:	1
Sink Dimensions:	15" x 15" x 5-3/16"
Bowl 1 Dimensions:	12" x 10" x 5"
Drain Size:	2" (51mm)
Drain Location:	Center
Minimum Cabinet Size:	18"
Mounting Hardware:	Part # 64090004 included for countertops up to 3/4" (19mm) thick
Cutout Template #:	1000001240

Template is available for download at [elkay.com](#)

Cutout Dimensions for Top Mount Installation:

14-3/8" x 14-3/8" (365mm x 365mm) with 1-1/2" (38mm) corner radius

NOTE: MUST BE ORDERED IN MULTIPLES OF 50



AMERICAN PRIDE. A LIFETIME TRADITION.

Like your family, the Elkay family has values and traditions that endure. For almost a century, Elkay has been a family-owned and operated company, providing thousands of jobs that support our families and communities.



Product Compliance: ADA & ICC A117.1
ASME A112.19.3/CSA B45.4
BUY AMERICAN ACT

Hole Drilling Configurations:

1-1/4" (32mm) Diameter Faucet Holes For 1 and 2 Hole Models

1-1/2" (38mm) Diameter Faucet Holes For 3 Hole Model

Faucet Holes on 4" (102mm) Centers

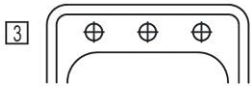

Installation Profile:

Silicone Caulk
(not furnished)

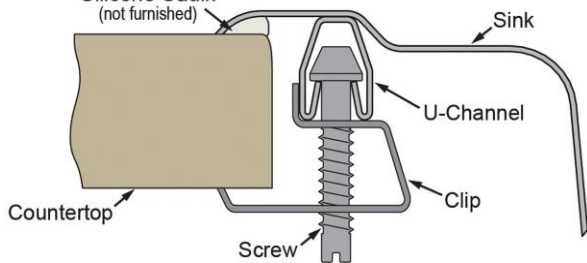

Sinks are listed by IAPMO[®] as meeting the applicable requirements of the Uniform Plumbing Code[®], International Plumbing Code[®], and National Plumbing Code of Canada.



Complies with ADA & ICC A117.1 accessibility requirements when installed according to the requirements outlined in these standards.

[Clean and Care Manual \(PDF\)](#)
[Installation Instructions \(PDF\)](#)
[Warranty \(PDF\)](#)

Similar models are available with: one sink per box

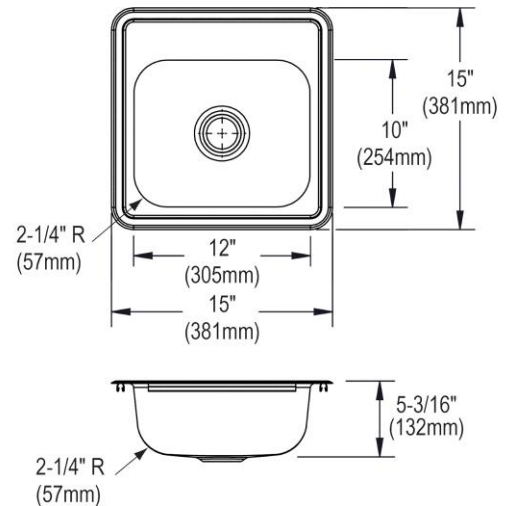

PART: _____ QTY: _____

PROJECT: _____

CONTACT: _____

DATE: _____

NOTES: _____

APPROVAL: _____

In keeping with our policy of continuing product improvement, Elkay reserves the right to change product specifications without notice. Please visit [elkay.com](#) for the most current version of Elkay product specification sheets. This specification describes an Elkay product with design, quality, and functional benefits to the user. When making a comparison of other producers' offerings, be certain these features are not overlooked.

OPTIONAL ACCESSORIES

Cutting Board:	CB912
Drain:	D5018A
Hardware:	LK364, LK463
Sinkmate:	LKSMHSL

In keeping with our policy of continuing product improvement, Elkay reserves the right to change product specifications without notice. Please visit elkay.com for the most current version of Elkay product specification sheets. This specification describes an Elkay product with design, quality, and functional benefits to the user. When making a comparison of other producers' offerings, be certain these features are not overlooked.