

PRODUCT SPECIFICATIONS

Elkay Lustertone™ Classic Stainless Steel 37-1/4" x 17" x 6-1/2", Double Bowl Drop-in Classroom ADA Sink. Sink is manufactured from 18 gauge 304 Stainless Steel with a Lustrous Satin finish, Center drain placement, and Bottom only pads.

Installation Type:	Drop-in
Material:	304 Stainless Steel
Special Features:	Quick-Clip Mounting System
Finish:	Lustrous Satin
Gauge:	18
Sound Deadening:	Bottom only pads
Number of Bowls:	2
Sink Dimensions:	37-1/4" x 17" x 6-1/2"
Bowl 1 Dimensions:	9-1/4" x 12" x 3-1/2"
Bowl 2 Dimensions:	16" x 11-1/2" x 6-3/8"
Drain Size:	2" (51mm), 3-1/2" (89mm)
Drain Location:	Center
Minimum Cabinet Size:	42"
Mounting Hardware:	Included for 3/4" (19mm) countertop

Cutout Dimensions for Top Mount Installation:
36-5/8" x 16-3/8" (930mm x 416mm) with 1-1/2" (38mm) corner radius

Hole Drilling Configurations:
1-1/2" (38mm) Diameter Faucet Holes on 4" (102mm) Centers
1-1/8" (29mm) Diameter Slotted Hole

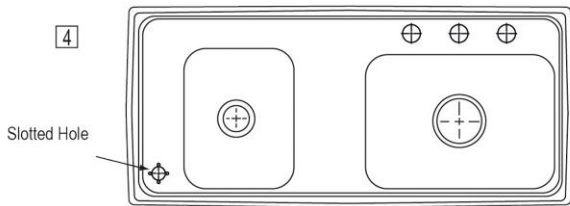

Installation Profile:

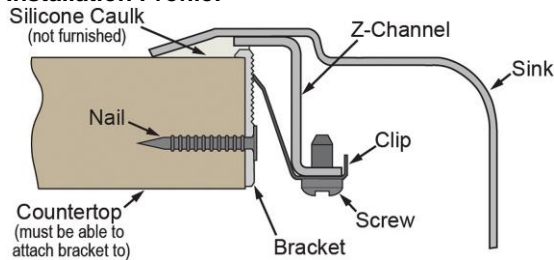

AMERICAN PRIDE. A LIFETIME TRADITION.
Like your family, the Elkay family has values and traditions that endure. For almost a century, Elkay has been a family-owned and operated company, providing thousands of jobs that support our families and communities.



Product Compliance: ADA & ICC A117.1
ASME A112.19.3/CSA B45.4
BUY AMERICAN ACT



Sinks are listed by IAPMO® as meeting the applicable requirements of the Uniform Plumbing Code®, International Plumbing Code®, and National Plumbing Code of Canada.



Complies with ADA & ICC A117.1 accessibility requirements when installed according to the requirements outlined in these standards.

[Clean and Care Manual \(PDF\)](#)
[Installation Instructions \(PDF\)](#)
[Limited Lifetime Warranty \(PDF\)](#)

Similar models are available with: additional ADA depths, U Channel mounting system

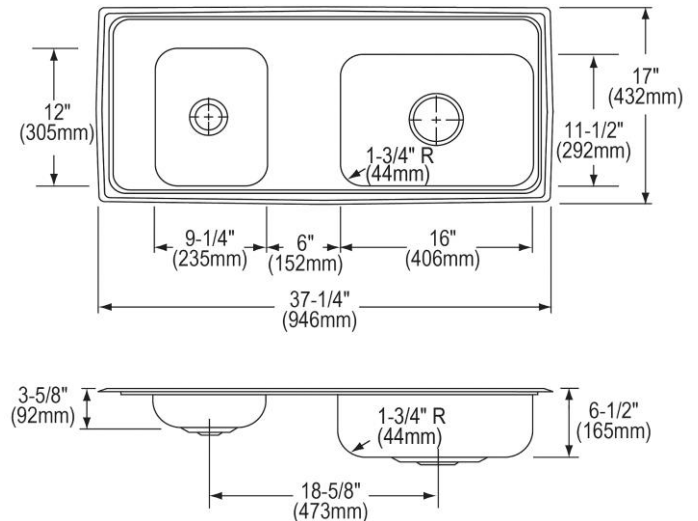

PART: _____ QTY: _____
PROJECT: _____
CONTACT: _____
DATE: _____
NOTES: _____
APPROVAL: _____

In keeping with our policy of continuing product improvement, Elkay reserves the right to change product specifications without notice. Please visit elkay.com for the most current version of Elkay product specification sheets. This specification describes an Elkay product with design, quality, and functional benefits to the user. When making a comparison of other producers' offerings, be certain these features are not overlooked.

OPTIONAL ACCESSORIES

Sinkmate:	LKSMHSL
-----------	---------

In keeping with our policy of continuing product improvement, Elkay reserves the right to change product specifications without notice. Please visit elkay.com for the most current version of Elkay product specification sheets. This specification describes an Elkay product with design, quality, and functional benefits to the user. When making a comparison of other producers' offerings, be certain these features are not overlooked.