



Sink - Tara.

Wall-mounted three-hole lavatory mixer without drain - polished chrome

Article number: 36 717 892-00 0010



- 9-1/2" Projection
- Rigid spout
- Round aerated stream
- Valve hole diameter 1-5/8"
- Spout hole diameter 1-5/8"
- Flange diameter 2-1/8"
- Water flow rate limited to max. 1.2 gpm
- lead-free
- (ADA)



polished chrome



Accessory is required for this item.

Dimensional drawing

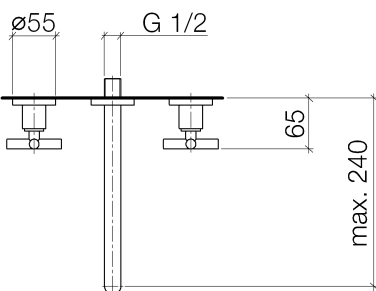
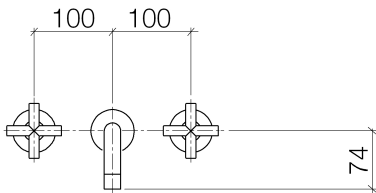



Sink - Tara.

Wall-mounted three-hole lavatory mixer without drain - polished chrome

Article number: 36 717 892-00 0010

All dimensions in mm / inch = mm x 0,0394

Flow rate chart

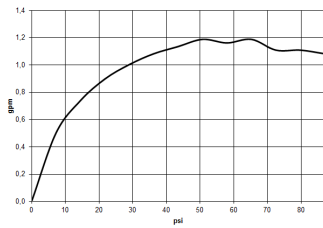



Sink - Tara.

Wall-mounted three-hole lavatory mixer without drain - polished chrome

Article number: 36 717 892-00 0010

Other surface finishes



platinum matte

36 717 892-06 0010

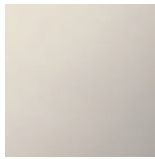

platinum

36 717 892-08 0010

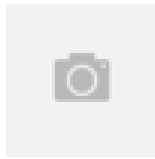

Brushed Durabronz

36 717 892-28 0010

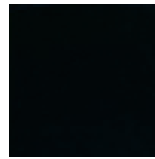

black matte

36 717 892-33 0010



Dark Platinum matte

36 717 892-99 0010

More custom finish options are available via special production (xTra Service). Please see our finish matrix for availability and pricing or contact a Dornbracht representative.

Required article



35 707 970-90 0010

Rough for wall-mounted faucet spout in center -



35 712 970-90 0010

Rough for wall-mounted faucet flexible positioning -



35 713 970-90 0010

Rough for wall-mounted faucet spout on left -



35 714 970-90 0010

Rough for wall-mounted faucet spout on right -



Sink - Tara.

Wall-mounted three-hole lavatory mixer without drain - polished chrome

Article number: 36 717 892-00 0010

Spare parts list

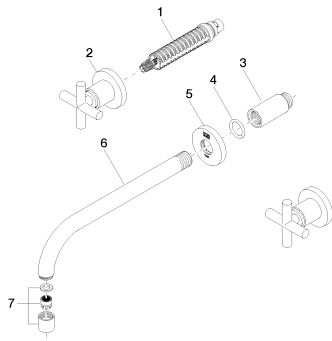

Number	Item Number	Designation	Number of units
1	90 90 03 157 00 90	top	2
2	36 310 892-00	Volume Control - polished chrome	2
3	09 24 03 081 10 90	extension	1
4	09 14 10 026 90	seal	1
5	09 27 22 501-00	rosette	1
6	04 28 22 105 10-00	spout	1
7	90 23 01 019 02-00	aerator	1