

52688 ▲

Submitted Model No.: _____

Specific Features: _____

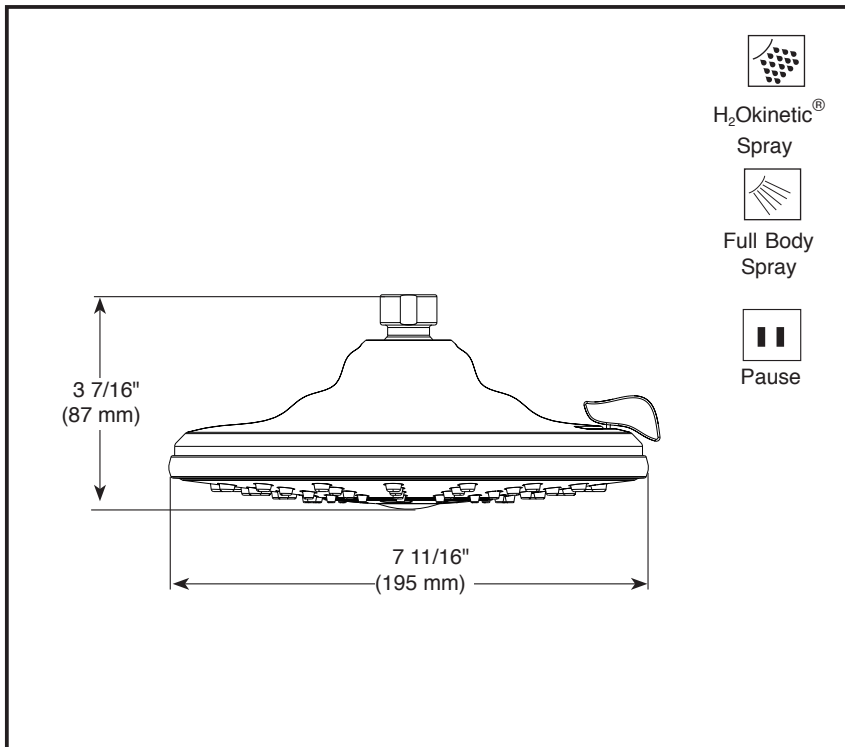

▲ Designate proper finish suffix



see what Delta can do™

SHOWERHEAD

■ 3-Spray Setting Showerhead

FEATURES:

- Touch-Clean® Nozzles
- H₂Okinetic Technology® Showerhead

STANDARD SPECIFICATIONS:

- Maximum 1.75 gpm @ 80 psi, 6.6 L/min @ 550kPa
- Showerhead with three settings – pause is a non-positive shut-off
- Standard 1/2" pipe fitting
- Easy-turn spray dial
- Metal ball connector

WARRANTY

- Lifetime limited warranty on parts (other than electronic parts and batteries) and finishes; or, for commercial users, for 5 years from the date of purchase.
- 5 year limited warranty on electronic parts (other than batteries); or for commercial users, for 1 year from the date of purchase. No warranty is provided on batteries.



COMPLIES WITH:

- ASME A112.18.1 / CSA B125.1
- EPA WaterSense®

Delta reserves the right (1) to make changes in specifications and materials, and (2) to change or discontinue models, both without notice or obligation. Dimensions are for reference only. See current full-line price book or www.deltafaucet.com for finish options and product availability.

Delta Faucet Company

55 E. 111th Street, Indianapolis, IN 46280
 350 South Edgeware Road, St. Thomas, ON N5P 4L1
 © 2017 Delta Faucet Company