

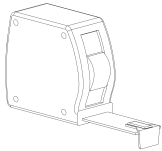

CARE AND CLEANING

- DO NOT OVERTIGHTEN DRAIN. Overtightening of the drain can damage your DECOLAV® product.
- DO NOT clean the product with Detergents, Acid, Abrasives, Harsh Cleaners or a cloth with a coarse surface (S.O.S.® Pads, Scotch Brite® Pads). This is good advice for any plumbing fixture regardless of material.
- DO NOT leave any cleaning agents other than water on your DECOLAV® product.
- DO NOT allow your DECOLAV® product to unnecessarily encounter other solid objects.
- DO clean your DECOLAV® product. Wipe with a damp cloth and dry with a soft cloth. If necessary, a general mild soap and water solution can be used.

RECOMMENDED TOOLS



Tape Measure

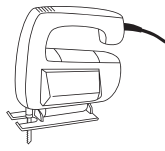

Scroll Saw

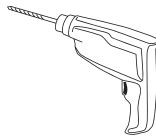

Drill

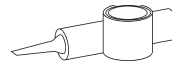
Plumber's Putty
or Caulking

Pencil

STEP #1

- o Affix Template provided for countertop at desired location with cellophane tape.
- o Mark guidelines on countertop in several places.
- o Drill a clearance hole approximately ¼" to ½" (0.64 to 1.27 cm) inside the perimeter line of Template.
- o Cut opening following the perimeter line of Template.

Figure A

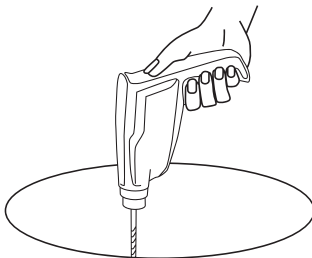

Clearance Hole

Figure B

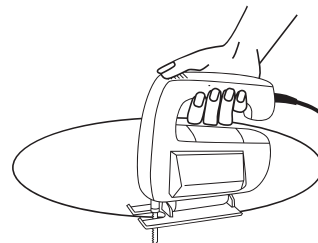

Cut Opening

STEP #2

- o Check for cutout alignment by placing Lavatory in desired mounting position.

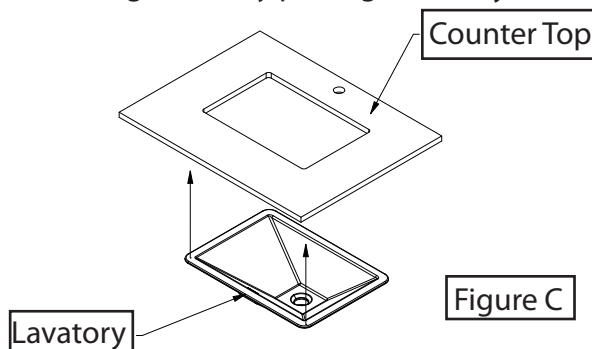



STEP #3

- o Insert brass insert nut into hole in bottom of counter top and epoxy into position, repeat for remain 3 insert nuts. Let epoxy cure before proceeding to the next step.
- o Apply sealant or plumbers putty to the rim of the lavatory. Figure D
- o Carefully raise Lavatory in place, align, press firmly. Figure D
- o Apply and tighten up under mount lavatory clips. Wipe off any excess sealant Figure E
- o NOTE: ALLOW SEALANT TO SET BEFORE PROCEEDING.

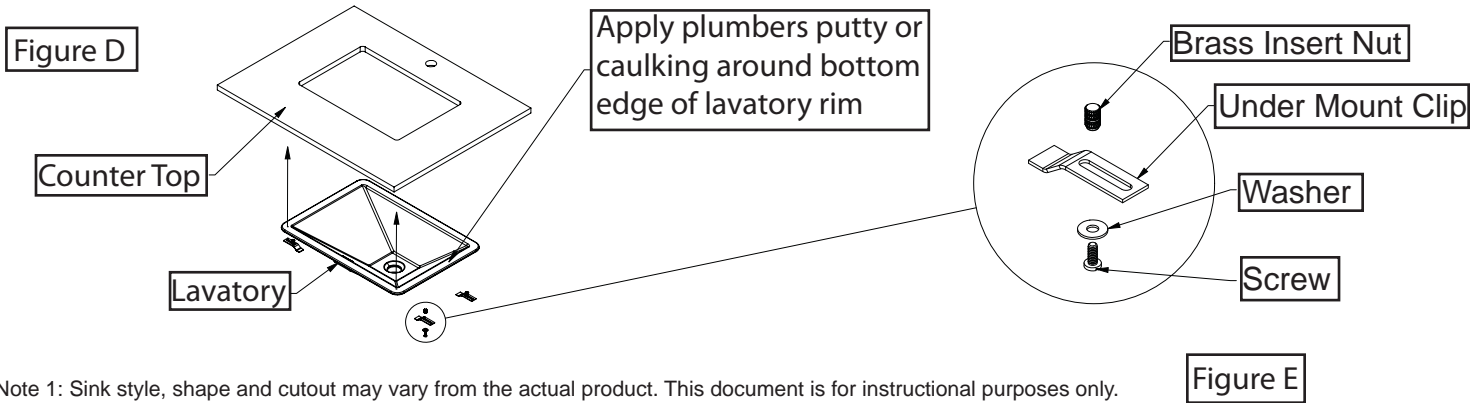

Note 1: Sink style, shape and cutout may vary from the actual product. This document is for instructional purposes only.
 Note 2: Decolav will not be held responsible if supplied cutout template is not followed

LIMITED LIFETIME WARRANTY

Any Deco Lav, Inc. ("DECOLAV") product(s), sold after December 1, 2010, will be warranted to the original end consumer to be free of true defects in material and workmanship during normal residential use for as long as the consumer owns his or her home subject to the following:

- Proof of purchase (original sales receipt) from the original end consumer must be made available to DECOLAV for all warranty claims.
- The person claiming a warranty issue must be able to establish original purchase and installation of the product.
- Authorized DECOLAV personnel have inspected the product(s) and determined the product(s) to have true manufacturing defect(s) (unless other arrangements satisfactory to DECOLAV have been agreed upon).
- Such product(s) are returned to DECOLAV (unless other arrangements satisfactory to DECOLAV have been agreed upon).
- The product must have been purchased, directly or indirectly, through an authorized DECOLAV reseller.

This limited warranty is non-transferable and applies only to the original end consumer and to the original installation of the product. This limited warranty is void if the product has been moved from its initial installation site or if ownership of the product has changed. DECOLAV's product are produced from natural raw materials and there may be a slight color variance from product appearing in catalogs, brochures, web-sites, or product samples, or prior production. These are not examples of manufacturing defects and will not be covered under this warranty.

This limited warranty does not cover any mechanical pieces of any DECOLAV product. These mechanical pieces will be covered under a One Year Warranty, with all other terms of this warranty applying except duration. This limited warranty does not cover the finish, color or plating of any DECOLAV product. The finish, color or plating of any product will be covered under a One Year Warranty, with all other terms of this warranty applying exception duration.

If this product is used commercially or installed outside of North America, DECOLAV warrants the product to be free from defects in material and workmanship for one (1) year from the date of installation with all other terms of this warranty applying except duration.

THIS LIMITED WARRANTY DOES NOT COVER ANY DAMAGES CAUSED BY SHIPPING, MISUSE, ABUSE, ACCIDENTS, NEGLIGENCE, UNAUTHORIZED REPAIRS OR ALTERATIONS, MODIFICATIONS, USE OF OTHER THAN GENUINE DECOLAV REPLACEMENT PARTS, DIRT, LIME SCALE, AND OTHER MINERALS, SCUFFS AND SCRATCHES, EXPOSURE TO MARINE AREAS, ABNORMAL USAGE, AND NORMAL WEAR AND TEAR. ANY IMPROPER INSTALLATION, IMPROPER MAINTENANCE, IMPROPER HANDLING, IMPROPER AND CONTRARY USES, IMPROPER CARE AND CLEANING AND ALL ACTS BEYOND DECOLAV'S CONTROL WILL VOID THIS LIMITED WARRANTY.

This limited warranty does not apply to local building code compliance. Since local building codes vary considerably, the original end consumer of the product(s) should check with a local building or plumbing contractor to ensure local code compliance prior to installation.

If you believe that you have a valid warranty claim, contact your Home Center, Dealer, Plumbing Contractor or E-tailer. Please be sure to provide all pertinent information regarding your claim, including a complete description of the problem, the product, model number, the date the product was purchased, from whom the product was purchased and the installation date and location. Also be sure to provide a copy of your original purchase invoice. For other questions, please write to us at: Deco Lav, Inc., Attn. Returns Processing, 314 S. Chimney Rock Road, Greensboro, NC 27409.

Upon satisfaction of each of the foregoing conditions and requirements, DECOLAV shall, at its option, either repair or replace the defective product. DECOLAV shall return any product repaired or replaced under this limited warranty to the original end consumer transportation prepaid. All Closeout/Discontinued product(s), at time of a valid warranty claim, will either be repaired or replaced with a comparable item. DECOLAV's option to repair or replace the product under this limited warranty does not cover any cost of labor to remove or install the DECOLAV product, usage and delay time, or other costs of removal or installation whatsoever. IN NO EVENT WILL DECOLAV BE LIABLE FOR THE COST OF REPAIR OR REPLACEMENT OF ANY INSTALLATION MATERIALS, INCLUDING BUT NOT LIMITED TO, COUNTERTOPS, TILES, MARBLE, GRANITE, ETC.

THIS LIMITED WARRANTY DOES NOT COVER ANY LIABILITY FOR CONSEQUENTIAL OR INCIDENTAL DAMAGES, ALL OF WHICH ARE HEREBY EXPRESSLY DISCLAIMED, OR THE EXTENSION BEYOND THE DURATION OF THIS LIMITED WARRANTY. Some states do not allow the exclusion or limitation of incidental or consequential damages, so the above limitation or exclusion may not apply to you.

THE WARRANTIES HEREIN:

- ARE EXCLUSIVE AND STATED IN LIEU OF ALL OTHER WARRANTIES, WHETHER EXPRESS, STATUTORY, OR IMPLIED, INCLUDING BUT NOT LIMITED TO THE WARRANTIES OF MERCHANTABILITY AND FITNESS FOR AN INTENDED PURPOSE, ALL OF WHICH ARE HEREBY EXPRESSLY DISCLAIMED.
- NEITHER ASSUME NOR AUTHORIZE ORIGINAL END CONSUMER NOR ANY OTHER PARTY TO ASSUME ANY OTHER LIABILITIES IN CONNECTION WITH THE MANUFACTURE OR SALE OF THE PRODUCT.
- ARE SUBJECT TO THE LIMITATIONS ON DAMAGES AS SET FORTH ABOVE.