

Formoso Grande Bathtub

US-N2ACS

Installation Instructions

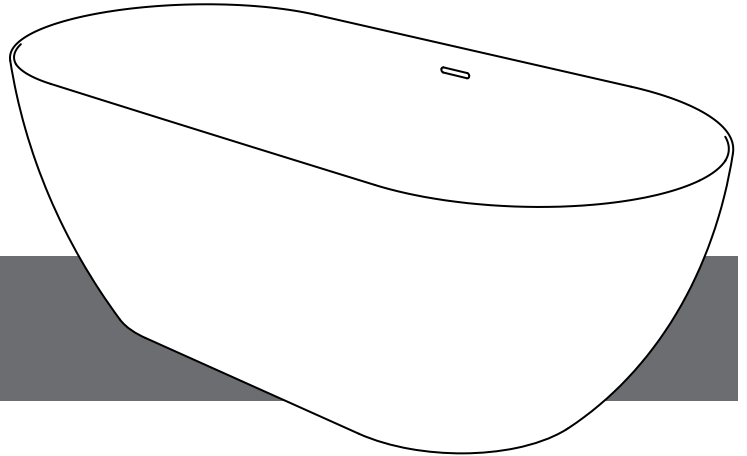

Introduction

This bathtub has been fully inspected throughout the production process and only leaves our factory after a 15-step QC process. Don't remove the old fixture before you unpack and inspect the new bathtub.

Carefully remove the bathtub from the box, taking care the bathtub is carried in the bag and check that all parts have been supplied.

Before beginning installation of the bathtub please check for any damage that may have occurred during transport. **Note: Damage claims cannot be made during or after installation.** Improper installation shall result in loss of warranty in case of damage caused by impacts or rubbing against rough surfaces.

Prior to installing the bathtub prepare a connection of water inlet/outlet.

Pay attention to leveling of floor where the bathtub will be located, ensuring it can take the weight of the bathtub, water and bather(s).

The customer may choose the type and location of the faucets, installation instructions should be supplied by the faucet manufacturer.

The installation procedure of the bathtub may differ from that described in the installation instructions, depending on where you wish the bathtub to be located.

Wet surface of the bathtub may create a risk of slipping which may increase by using soap, shampoo, oils and similar products.

IMPORTANT: Please read these instructions carefully before you begin and retain for future reference.

We do not accept responsibility for any problems that may occur through incorrect installation.

RECOMMENDATIONS:

- Walls and floor should be fully tiled and finished before installation. This ensures that the product is installed flat to the tile face and allows the product to be easily removed if required in the future.
- Remove the protective packaging after installation of the bathtub.
- Only fill the bathtub with water up to 2/3 of its height.
- Use **US-CW12** and **ITD5135** waste flow products with this bathtub.

Installation notes

The installation must comply with all plumbing codes including local codes and be installed by a licensed plumbing contractor.

Store the bathtub in a safe place until you begin installation to avoid any damage.

Assemble the bathtub on a mat to protect against damage to the bathtub surface.

Avoid getting cement, grit, sand or masonry products on to the surface. Protect and cover the bathtub during the installation period to prevent damage from occurring.

Never use brown tape or gaffer tape directly on to the surface. If the bath has to be repacked remember to avoid taping directly on to the surface of the bathtub.

IMPORTANT: Turn off the main water supply before connecting to any existing pipe work or doing any maintenance.

WARNING! Please check for any hidden pipes and cables, electric or otherwise, before drilling holes in a wall or floor.

Dimensions



2/3 Height = 48 Gal./182L

Weight - 185lbs
Weight with water - 586lbs

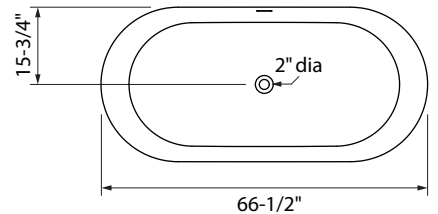

31-1/2"

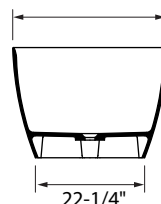

22-1/4"

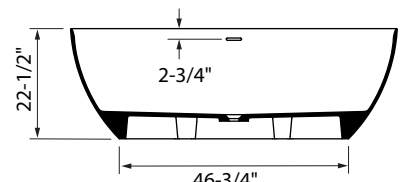

22-1/2"

46-3/4"

Tools required



Tape measure



Safety glasses

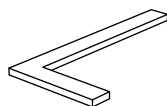

Set square

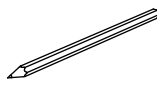

Pencil

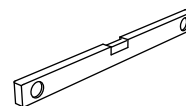

Spirit level

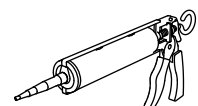

Silicone sealant

1 Installation - carriage

IMPORTANT:

This bathtub is heavy and installation requires 2 people. Crosswater London cannot accept responsibility for any injuries caused to those attempting to install this bathtub without adequate and appropriate tools or resources.

- Remove the bathtub from the packaging using the bag with handles.

- Use the bag with handles to lift and move the bath tub.
- **Do not** drag the bathtub over rough surfaces or sharp objects. Lift and place the bathtub into position.
- **Do not** drop the bathtub!
- Check that the wedges have been supplied.

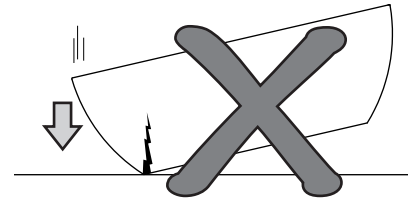
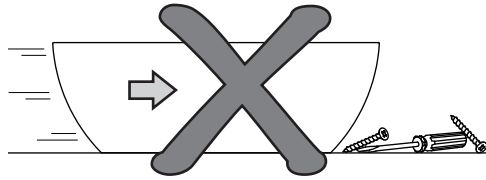
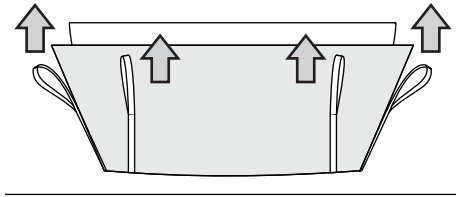
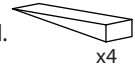

2 Installation

- This installation guide does not include details of waste connection; final decision about installation of waste connection should be made by a licensed plumber..
- Install the waste according to the installation instructions supplied with the waste.

WARNING: DO NOT OVERTIGHTEN the waste as this may cause long-term damage to the bath. We recommend to use a torque wrench to tighten the waste by using a torque force between 25Nm or 18.5 ft/lb and 50Nm or 36.8 ft/lb.

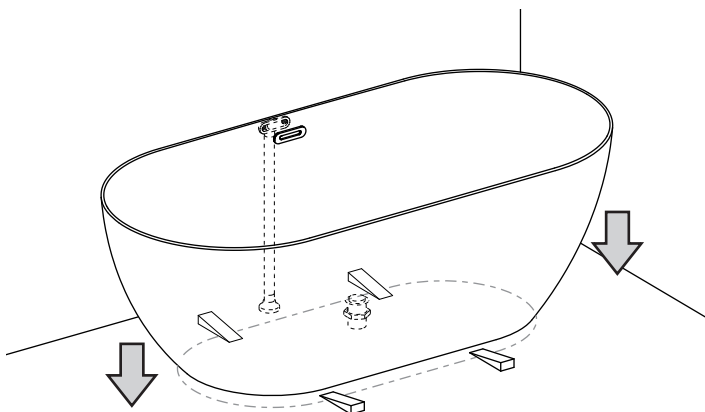
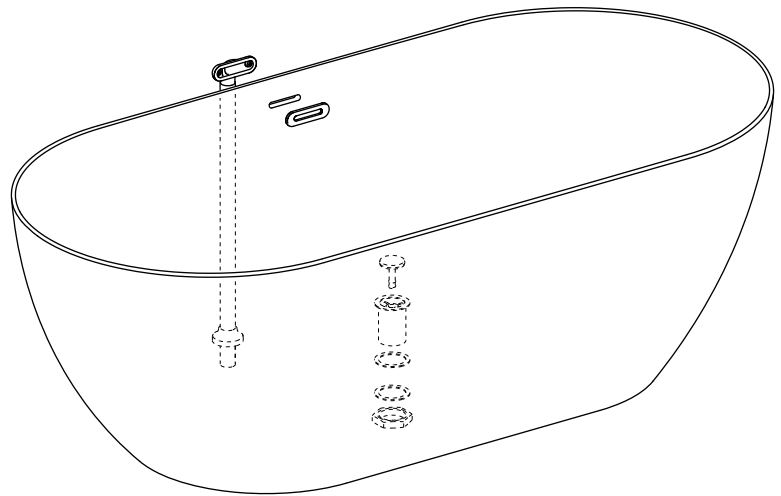

- Place the 4 wedges in position.



- Once sealed, the wedges can be disposed of.

3 Cleaning Instructions

Clean the bath regularly with non-abrasive soap and warm water. Fully rinse after cleaning.

While Clearstone is highly stain resistant, it is recommended that bath water containing additives such as oils or salts is always drained and rinsed immediately after use.

Please note that hair dyes and color cosmetics (eg. mascara, lipstick, face powder) may leave a slight discoloration if not removed immediately. If any strong chemicals come into contact with the bathtub, remove and rinse immediately.

Water temperature should not exceed 49°C/120°F.

For a fine scratch or a slight mark, use a 1500 grade sandpaper. Gently sand the area with water. For best results, limit sanding to the smallest possible area around the scratch. Re-polish the surface afterwards using a neutral polishing compound or toothpaste. It may be possible to polish very fine scratches away without using abrasive papers: scrub gently with a soft brush or plastic pad (not metal scouring pad) and a mildly abrasive cream cleaner. Afterwards scrub the whole area with plenty of clean water and re-polish as before.

If the scratch or mark is too deep and cannot be repaired using the above method, it is possible to purchase a repair kit **US-CRK**. In order to remove the scratches, follow the instructions included with the kit.

Warranty - This **Crosswater London** product is covered by a limited lifetime warranty. For full details, terms and conditions please visit our website.

For further information contact: **Crosswater London**, 393 Fortune Blvd., Milford, MA 01757

www.crosswaterlondon.com

Toll free number: 844-XWATER-1 (844-992-8371) tel: 508-381-6062 fax: 508-381-6068

email: technical@crosswaterlondon.com